

USER MANUAL

Stormwater Load Analysis Tool (SLAT)

Version 2.1

August 2022

DEVELOPED BY
City of Austin Watershed Protection Department

Austin, Texas



DISCLAIMER

The information in this document has been funded wholly or in part by the City of Austin Watershed Protection Department (WPD). All copies of the tool reproduced by or for user will be and remain the property of WPD. It is requested that WPD be given appropriate acknowledgement in any subsequent use of this tool.

The use of SLAT does not constitute project approval by the City of Austin. All development projects shall be reviewed, approved, and permitted through the City of Austin Development Services Department prior to construction.

Neither WPD, nor any of its employees, makes any warranty, express or implied, or assumes any legal liability or responsibility for the accuracy, completeness, or usefulness of any information, product, or process disclosed. The user is solely responsible for the content, interactions, and effects of the tool and any and all amendments to the tool. As a voluntary user of SLAT you agree to indemnify and hold the COA and its representatives and employees harmless from any claim or demand made by you or any third party due to your use of SLAT.

This document contains references to product names that are trademarks or registered trademarks of their respective owners. Use of specific product names does not imply official or unofficial endorsement. Product names are used solely for the purpose of identifying products available in the public market place. Microsoft and Excel are registered trademarks of Microsoft Corp.

TABLE OF CONTENTS

I. Introduction 1

II. System Requirements 2

III. Calculation Assumptions..... 3

 A. Drainage Areas..... 3

 B. Stormwater Control Measures 4

 C. Base Impervious Cover 4

 D. Sites outside the Barton Springs Zone 4

 E. Pollutants 5

 F. Bypass Concentrations 5

IV. Calculation Procedure Overview 7

 A. Runoff Capture Efficiency Calculation 7

 B. Infiltrated Water Quality Volume and Infiltration Field Size 10

V. Row-by-Row Instructions..... 12

VI. Example Projects..... 19

 A. Two Drainage Areas Within Barton Springs Zone..... 19

 B. Alternative Controls Outside Barton Springs Zone..... 26

VII. References 32

APPENDIX A: SLAT Default Input Values 33

APPENDIX B: Updates to SLAT 34

I. INTRODUCTION

The City of Austin Stormwater Load Analysis Tool (SLAT) was developed in conjunction with 2014 updates to the Environmental Criteria Manual (ECM) Section 1.6, specifically 1.6.7 and 1.6.9. The goal of the tool is to calculate whether a site's proposed stormwater control measures: (1) comply with the load-based non-degradation requirements within the Barton Springs Zone, or (2) achieve load-based equivalency with a properly sized sedimentation/filtration control outside of the Barton Springs Zone. The tool is not meant to replace engineering analyses that may be needed, including but not limited to control measure design, stormwater conveyance design, and continuous simulation modeling for sites with routing or controls that do not fit the assumptions of the tool.

SLAT is not intended to replace or contradict any part of the ECM. Users must still comply with all ECM requirements, even if they are not explicitly evaluated or used in SLAT.

This user manual is consistent with SLAT Version 2.1. For a list of updates compared to the previous SLAT Versions, see [Appendix B](#).

SLAT has the following key advantages:

1. SLAT accommodates alternative stormwater control measures (SCMs) by allowing the user to manually input pollutant effluent concentrations.
2. SLAT streamlines design calculations by automatically calculating site runoff volume, SCM runoff capture efficiency, and minimum infiltration field size.
3. SLAT generates output tables and plots that can be submitted to water quality review staff.
4. For sites outside the Barton Springs Zone utilizing alternative controls, SLAT can compare the pollutant load performance with a sedimentation/filtration system

SLAT also has limitations:

1. SLAT does not accommodate sites with more than four drainage areas (for a workaround, see Section III).
2. SLAT makes limiting assumptions about a site's stormwater routing and conveyance network (see Section III).

II. SYSTEM REQUIREMENTS

SLAT is an Excel-based tool. The user needs to have installed Microsoft Excel 2007 (or a more recent version) and be able to run Excel Macro (.xlsm) files.

The internal calculation formulas in SLAT are not intended to be edited or modified by users outside the Watershed Protection Department. If you suspect that there is an error with the formulas, please report it to the developers by contacting **SLAT@austintexas.gov**.

III. CALCULATION ASSUMPTIONS

This is a simplified analysis tool. Complex scenarios should be modeled with a continuous simulation model instead. Figure 1 shows a typical stormwater control measure (SCM) layout that would work well with SLAT.

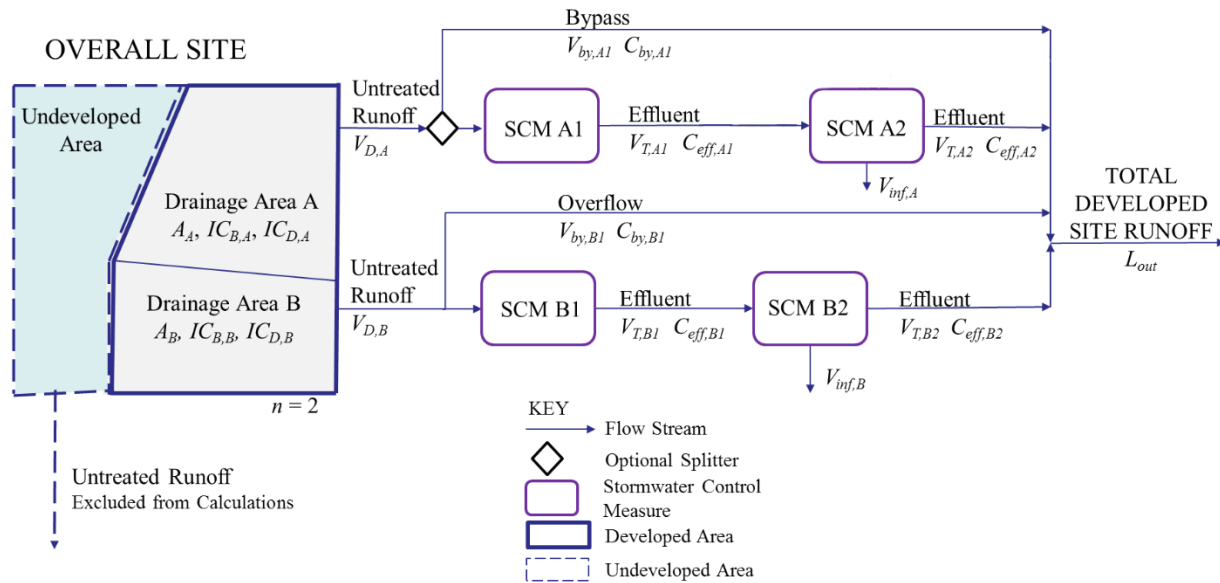

Figure 1: Typical site and stormwater control measure configuration that can be evaluated using SLAT.

The following are some initial assumptions and definitions to help the user evaluate whether SLAT is appropriate for their proposed site.

A. Drainage Areas

A drainage area is the physical area of land that contributes to one SCM or a series of SCMs. Depending on the site’s developed conditions, a drainage area is a subwatershed with natural or engineered boundaries. Each drainage area is assigned an impervious cover percentage. In SLAT, when comparing proposed developed conditions to existing conditions, the physical boundaries and size of the drainage areas stay the same, and are defined by the developed site condition. Note that landscaped areas are considered pervious but developed, meaning that while they do not add to the impervious cover percentage, they must still be included in a drainage area.

Maximum Number of Drainage Areas

SLAT can evaluate up to four distinct drainage areas for one site. If the user wants to analyze five or more drainage areas with SLAT, they can open multiple SLAT spreadsheets and add the

resulting loads together. Note that when the user has more than one drainage area, the discharge location(s) must still comply with ECM requirements.

A. Stormwater Control Measures

Also known as BMPs, stormwater control measure (SCM or control) is an engineered system designed to capture and/or treat stormwater. Refer to the ECM for a list of SCMs allowed inside and outside the Barton Springs Zone.

SCMs in Parallel and in Series

SLAT cannot evaluate multiple controls in parallel which share a drainage area. Controls in parallel should be modeled with separate drainage areas or a continuous simulation model.

SLAT can evaluate a series of up to two SCMs from a single drainage area. For the second SCM in series, such as when modeling a retention/irrigation system, only flow routed through the first SCM can be considered influent to the second SCM. Overflow from the first SCM is assumed to flow directly offsite. If this is not the case, the user should use a continuous simulation model.

B. Base Impervious Cover

While the existing condition of most sites is undeveloped (0% impervious cover), and this is the SLAT default, the user may input a non-zero number as the base impervious cover percentage to account for existing impervious cover. The use of non-zero base impervious cover should be consistent with the Land Development Code and should be verified with water quality review staff.

C. Sites outside the Barton Springs Zone

SLAT's primary intended purpose is to calculate load compliance for sites within the Barton Springs Zone. However, for sites outside the Barton Springs Zone, SLAT can be used to compare load equivalence to sedimentation/filtration systems. The assumed parameters for the comparable system are based on the water quality capture volume requirements of ECM 1.6.2 and sedimentation/filtration design guidelines in ECM 1.6.5, specifically: water quality volume is a function of the impervious cover ("half-inch-plus" rule), control is off-line (contains splitter), drawdown time is 48 hours with no lag time before beginning of discharge, and no treatment train (no second control in series). The end result is a Load Equivalence Factor that compares the proposed system to a standard sedimentation/filtration system rather than the "existing" conditions of the site.

D. Pollutants

SLAT calculates pollutant concentrations for seven pollutants. The following list summarizes the pollutant abbreviations and concentration units used in SLAT. SLAT's conversion factors are consistent with the listed concentrations. If the user chooses to provide effluent concentration data, the input values should have correct units. Metal concentrations, in particular, are often $\mu\text{g/L}$ in other sources.

COD Chemical Oxygen Demand, mg/L

E. coli Escherichia coli, CFU/100 mL

Pb Total lead, mg/L

TN Total nitrogen, mg/L

TP Total phosphorus, mg/L

TSS Total suspended solids, mg/L

Zn Total zinc, mg/

E. Bypass Concentrations

SLAT determines pollutant concentration in the bypass flows using regressions based on City of Austin stormwater monitoring data. Typically, concentrations of contaminants in stormwater vary throughout the storm and tend to be higher in the first portion of stormwater runoff. This is known as "first flush" (California Department of Transportation 2005).

SLAT bypass concentrations are based on runoff data that has been collected and analyzed by COA staff (WPD 2014). Figure 2 is an example of the variation in zinc over the course of a storm. As the storm progresses and cumulative runoff increases, the measured pollutant concentration decreases exponentially. In other words, when an SCM captures the first flush, it also captures the dirtiest water. The remaining volume of runoff that bypasses is cleaner, having a lower pollutant concentration.

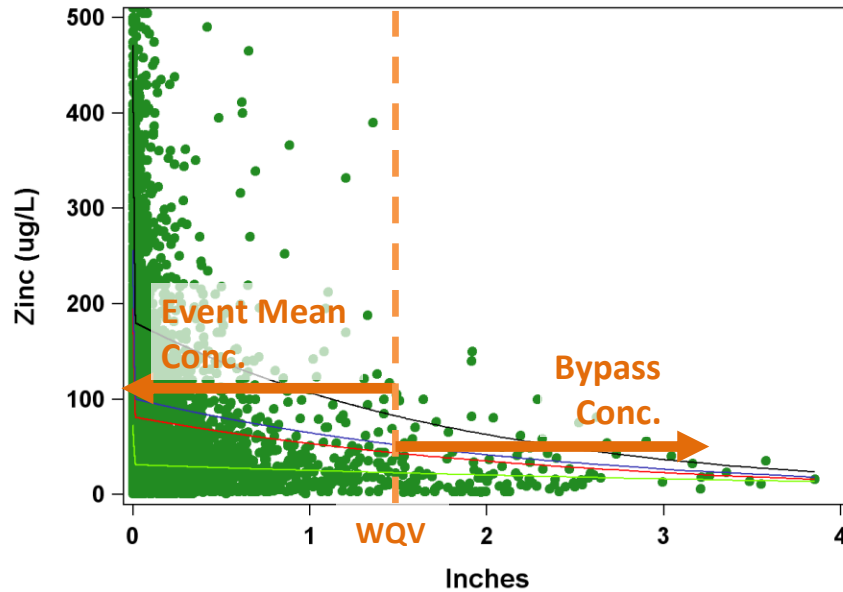

Figure 2: Example of variation of zinc concentration throughout a storm and effect on effluent concentration of an SCM with a 1.5 inch capture volume.

While a constant event mean concentration (EMC) is assumed for raw runoff that receives no treatment, SLAT assigns a bypass concentration (C_{by}) to runoff that bypasses a control. SLAT calculates the bypass concentration as an exponential function of water quality volume. For each pollutant, there are two different functions. The first applies to controls that are “off-line” (contain splitters) and isolate the first flush. The second applies to controls that are “on-line” (do not contain splitters) and have some mixing throughout the storm.

The bypass concentration expression is conservative. Rather than being a “partial event mean concentration,” the bypass concentration is calculated at the point that runoff volume equals water quality volume, and this concentration is assumed for the remainder of the bypassing flow. In cases where the exponential regressions are highly conservative and exceed the EMCs, according to ECM Table 1-12 the bypass concentration should simply be equal to the event mean concentration, i.e. C_D from ECM Table 1-10. SLAT does this calculation automatically. Concentrations for flows that bypass SCM 2 are assumed to be equal to the effluent concentration of SCM 1, per Table 1-12. This is due to the assumption discussed in III.0.

IV. CALCULATION PROCEDURE OVERVIEW

SLAT follows the procedures outlined in ECM Section 1.6.9. Any user should be able to manually replicate the results of the SLAT using only the equations and tables in Section 1.6.9. The equations are not repeated here although Figure 3 provides a flowchart overviewing the load compliance calculations detailed in ECM 1.6.9.

Since SLAT can calculate a range of design scenarios at once, such as multiple drainage areas, different types of SCMs, and other user input options, the spreadsheet’s functions do have an additional built-in layer of logic. In SLAT, the two worksheets intended for user interaction are “1. ENTER DATA” and “2. RESULTS.” Worksheets three through six contain the internal calculations and can be viewed, though not edited.

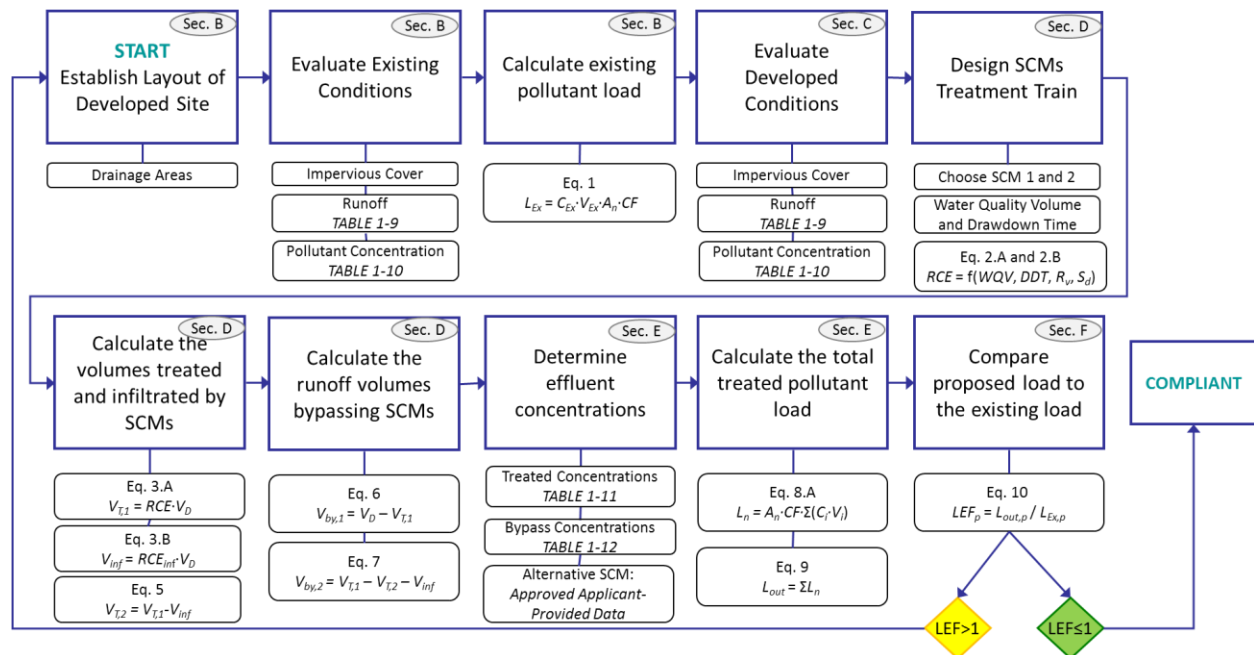

Figure 3: Flowchart with calculation overview

A. Runoff Capture Efficiency Calculation

SLAT uses a probabilistic methodology which uses rainfall statistics to calculate runoff capture efficiency. The probabilistic methodology is considered to be an alternative to continuous simulation modeling for conducting planning level analyses, but still requires understanding of meteorological conditions and urban drainage design and practice. The procedure is based off of a method derived in the book *Urban Runoff Management Planning with Analytical Probabilistic Models* (Adams and Papa, 2000).

The following excerpt from the preface describes the methodology:

It is an approach based on analytical models formulated with derived probability distribution theory. Rather than running time series of numerical meteorological data through simulation programs, the meteorology is described by the probability distribution of its characteristics: rainfall volume, duration, average intensity, and interevent time. These input probability distributions are then mathematically transformed by hydrologic and hydraulic models to create probability distributions of system outputs. These analytical models are often closed-form mathematical equations that describe the complete probability distributions of system performance parameters. Because of their analytical form, these models are extremely compact, computationally efficient, and easy to use.

Rainfall Statistics

The following rainfall statistics provide basic input into the model and remain constant for all analyses. The statistics were produced by WPD staff, which used SWMM to analyze 45 years of hourly rainfall data (1948-1993) from the Mueller airport. (Note: This data is subject to COA updates with more recent rainfall data, which may result in changes to the calculated runoff capture efficiency.)

v = mean annual rainfall event volume = 0.40 inches

t = mean annual rainfall event duration = 5.77 hours

b = interevent time = 103.63 hours

Variables

The following variables are derived from runoff monitoring data and are functions of the drainage area's proposed impervious cover percentage:

R_v = Runoff-rainfall ratio (unitless) (See ECM 1.6.9, Table 1.9)

S_d = depression storage (inches) (See ECM 1.6.9, Table 1.9)

The following variables are chosen by the designer and relate to the proposed stormwater control measure (SCM):

WQV = water quality volume of the control (inches)

DDT = drawdown time of the control (hours)

t_L = lag time between end of storm event and beginning to drain control (hours)

t_D = drain time, or total time for full control to empty (hours)

For pumped systems: $t_D = DDT + t_L$

For gravity-drained systems: $t_D = DDT$

Runoff Capture Efficiency

The probability of a spill of any size occurring, $G_p(0)$, is defined by the following expression, which is taken from Equation 8.4a in the book (Adams and Papa, 2000). This expression makes the conservative assumption that the SCM is full at the end of the last rain event.

$$G_p(0) = \frac{\frac{\lambda}{\Omega}}{\frac{\lambda}{\Omega} + \frac{\zeta}{\phi}} * \frac{\left(\frac{\psi}{\Omega}\right) + \left(\frac{\zeta}{\phi}\right) e^{-\left(\frac{\psi}{\Omega} + \frac{\zeta}{\phi}\right) S_A}}{\frac{\psi}{\Omega} + \frac{\zeta}{\phi}} e^{-\zeta \cdot S_d}$$

Where:

λ (lambda) = $1/t$ (hrs⁻¹)

Ω (omega) = treatment rate of the BMP = WQV/t_D (ft³/hr)

ζ (zeta) = $1/v$ (in⁻¹)

ψ (psi) = $1/b$ where b is the interevent time period (hrs⁻¹)

ϕ (phi) = R_v = Runoff-Rainfall coefficient (unitless)

S_A = WQV = Water quality volume (inches)

S_d = depression storage (inches)

Runoff capture efficiency (*RCE*) is the fraction of the average annual runoff volume that is captured, i.e. not spilled, by the SCM. An *RCE* of zero represents no capture of the yearly average runoff volume (complete spillage), and an *RCE* of one represents complete capture of the yearly average runoff volume.

$$1 = RCE + G_p(0)$$

Combining the above two equations and substituting for the defined statistics and variables yields the following expression for runoff capture efficiency:

$$RCE = 1 - \frac{t_D}{t_D + \frac{t \cdot WQV}{v \cdot R_v}} * \frac{\left(\frac{t_D}{b \cdot WQV}\right) + \left(\frac{1}{v \cdot R_v}\right) \exp\left[-\left(\frac{t_D}{b \cdot WQV} + \frac{1}{v \cdot R_v}\right) WQV\right]}{\frac{t_D}{b \cdot WQV} + \frac{1}{v \cdot R_v}} \exp\left(\frac{-S_d}{v}\right)$$

Equation 1

Equation 1 is given in ECM 1.6.9.3. However, Equation 2 is used in SLAT as a more general expression that uses flow rate, Ω , instead of WQV/DDT. It allows the user to input either flow rate or drawdown time, providing more flexibility for alternative controls used outside the Barton Springs Zone.

$$RCE = 1 - \left(1 + \frac{t \cdot \Omega}{v \cdot R_v}\right)^{-1} \left(1 + \frac{b \cdot \Omega}{v \cdot R_v}\right)^{-1} \left(1 + \frac{b \cdot \Omega}{v \cdot R_v} e^{-\left(\frac{1}{b \cdot \Omega} + \frac{1}{v \cdot R_v}\right) WQV}\right) e^{-\frac{S_d}{v}} \quad \text{Equation 2}$$

B. Infiltrated Water Quality Volume and Infiltration Field Size

The infiltrated or irrigated water quality volume is typically chosen by the designer. Since the load calculations are based on surface runoff only, all volume that is infiltrated, irrigated, beneficially reused, or otherwise removed from surface flow is also removed from the load calculations. Therefore, increasing infiltrated volume helps match baseline loads.

For an infiltration or irrigation field with no ponding water, the infiltrated volume is correlated to the soil infiltration rate, the application time, and the size of the field. Knowing infiltrated volume can dictate field size, and vice versa, based on the following simplified expression for sizing retention/irrigation fields.

Application rate

To be conservative, for both gravity draining systems and irrigated systems, the maximum flowrate is assumed to size the infiltration area. This is defined as twice the average application rate of WQV_{inf} / DDT .

$$A_{field} = 2 \times \frac{WQV_{inf}}{DDT \cdot I} A_n$$

Equation 1

Where:

A_{field} = irrigation field size (Acres)

WQV_{inf} = Infiltrated water quality volume (inches)

DDT = Drawdown time, or time for first control to empty its full water quality volume, starting at the beginning of drawdown, assumed equal to the application or irrigation time (hours)

I = infiltration rate (in/hr)

A_n = Drainage area size (acres)

Annual Infiltrated Volume

To convert from a known infiltrated water quality volume to a yearly average infiltrated volume V_{inf} , SLAT uses the runoff capture efficiency expression listed in Equation 1, but replaces the WQV of SCM 1 with WQV_{inf} . It is necessary to recalculate runoff capture efficiency because simply multiplying WQV_{inf} by the average annual number of rainfall events would result in an artificially high V_{inf} (some runoff events are less than the infiltrated water quality volume).

$$RCE_{inf} = 1 - \frac{t_D}{t_D + \frac{t \cdot WQV_{inf}}{v \cdot R_v}} * \frac{\left(\frac{t_D}{b \cdot WQV_{inf}}\right) + \left(\frac{1}{v \cdot R_v}\right) \exp\left[-\left(\frac{t_D}{b \cdot WQV} + \frac{1}{v \cdot R_v}\right) WQV_{inf}\right]}{\frac{t_D}{b \cdot WQV_{inf}} + \frac{1}{v \cdot R_v}} \exp\left(\frac{-S_d}{v}\right)$$

As with SCM 1, the result is then multiplied by the total runoff volume to determine the average annual volume infiltrated (inches per year):

$$V_{inf} = RCE_{inf} V_D$$

V. ROW-BY-ROW INSTRUCTIONS

The following screenshots are from MS Office 2010; other versions may appear differently.

Before Starting a New Project

1. Open the Excel file
2. Enable macros in the spreadsheet. If “Security Warning” pops up, click “Enable Content.”

If macros are not enabled, the calculations will still work, but the shortcut buttons, including “Restore Defaults,” will not work.

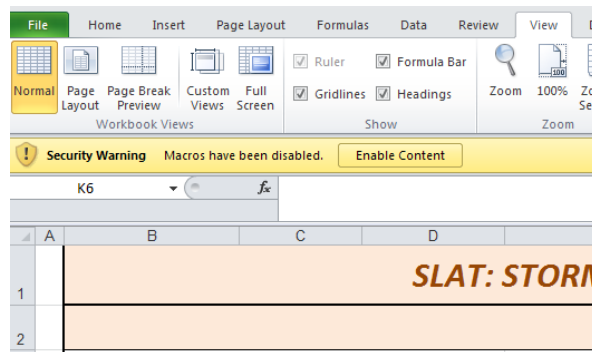

3. Open the “1. ENTER DATA” worksheet, if it is not already open.
4. Click “Restore Defaults” Button in the upper right corner. The SLAT default values are listed in [Appendix A](#).

When inputting data for a new project, the user should fill out the yellow highlighted cells. The following list describes all cell types that the user may encounter when performing an analysis.

| | |
|--------------------------------|--|
| Required User Input | Cell contains required user input. User should replace default values with site-specific information. |
| Key User Input | Cell contains an important variable for SCM sizing. User may choose to iterate with this variable during SCM design. |
| Internal Calculation | Cell is calculated based on user input. User does not change this cell. |
| Error | Warning that user input is inconsistent with other inputs, which may result in inaccurate calculations. |
| Calculator Output | Cell displays a key calculation result. |
| Does Not Apply | Cell is not applicable, based on previous user inputs. |

There are two worksheets that the user alternates between.

1. ENTER DATA – this is the primary worksheet where the user will input data
- 2.A RESULTS – this worksheet summarizes the results of the calculations, and provides plots to visualize load compliance.

Inputting Data for a New Project

The following instructions move through the user input cells from top to bottom. For all cell inputs, the user shall remain compliant with requirements of ECM 1.6.9 and all other relevant sections of the ECM and LDC, even if not specifically mentioned in this user manual or in SLAT. All inputs are subject to approval by the plan reviewer.

Row 12: Basic Info

Input name to identify site (such as address or development), name of person who is performing analysis, and date of analysis. This information is for tracking purposes only.

Row 14: Is your site within the Barton Springs Zone?

Yes - Site development is subject to Section 25-8-514 of the Land Development Code (LDC), and tool is being used to demonstrate that proposed loads are less than or equal to existing conditions loads.

No – Site development is not subject to the above-referenced standards. Selecting “No” allows the user to demonstrate equivalence (full or partial) with sedimentation/filtration performance outside of the Barton Springs Zone.

Row 15: How many drainage areas, n_{max} , does your site have?

Input a number from 1 to 4. In SLAT, each drainage area is assumed to be treated by a separate treatment train, with no intermixing of runoff between drainage areas. See ECM Section 1.6.9 for definition of drainage area.

If the user activates more than one drainage area, additional columns become highlighted. Each drainage area is distinct, and the below instructions apply to each drainage area that is activated.

If a site has more than four drainage areas, they can still use SLAT. However, they would need to create additional drainage areas in a second SLAT spreadsheet. To prove load compliance, the user would need to manually add the Developed Load and Existing Loads from both “2. RESULTS” worksheets, ensuring that all drainage areas are included. They would then need to calculate an overall load equivalency factor (LEF) to demonstrate compliance.

Row 17: Drainage area to the control, A_n (acres)

Input the area, in acres, that drains to the SCM.

Row 18: Base impervious cover of the drainage area, IC_B (%)

Input the percentage of impervious cover in the drainage area for the existing condition. Input as a whole number from 0 and 100 (i.e. for 50%, input “50” rather than “0.50”). Definitions must comply with the Land Development Code Section 1.9.2 and should be agreed upon by the plan reviewer. For a completely undeveloped site, the input is 0.

Row 19: Developed impervious cover of the drainage area, IC_D (%)

Input the percentage of impervious cover in the drainage area for the proposed developed condition. Input as a whole number from 0 and 100 (i.e. for 50%, input “50” rather than “0.50”).

Row 24: SCM Type

From the drop-down list, select the proposed stormwater control measure that is first in series. If “Alternative” is selected, rows 62 through 68 will become activated and the user will need to input the effluent concentration later.

Row 25: Is SCM 1 off-line?

Select whether the SCM is off-line or on-line. An off-line control isolates the water quality volume when the control is full, and typically a splitter box is used. If SCM 1 is a retention basin, an off-line control is required.

Row 26: What is the water quality volume, WQV (inches) [aka Capture Depth]?

Input the proposed water quality capture volume, also known as capture depth, in inches. Water quality volume is independent of drainage area size.

For example, a control with water quality volume of 2.0 inches would capture 100% of runoff from all storms that produce two inches or less runoff, but would have bypass for greater than two inches of runoff. The larger the water quality volume, the higher the runoff capture efficiency.

If the entered water quality volume is zero (only allowed outside the Barton Springs Zone), there is assumed to be no second control in series.

Row 27: Minimum water quality volume allowed

Displays, for user reference, the minimum water quality volume allowed for each drainage area. Within the Barton Springs Zone, the minimum water quality volume follows the “Half-Inch Plus” rule for sizing water quality ponds per ECM Section 1.6.2. Outside the Barton Springs Zone, the minimum water quality volume is set to 0, as in these cases SLAT is may be used to determine partial equivalence to a standard sedimentation/filtration system.

Row 28: SCM 1 Actual Volume (ft³)

Displays, for user reference, the actual volume of the control when accounting for the size of the drainage area. Note that this is for water quality purposes only, and does not include freeboard. To convert to actual volume, the water quality volume is multiplied by the drainage area:

$$WQV \text{ (ft}^3\text{)} = WQV \text{ (in)} \times DA \text{ (Ac)} \times 3630 \left(\frac{\text{ft}^3}{\text{Ac-in}} \right)$$

Row 29: Do you know the drawdown time or flow rate?

For controls within the Barton Springs Zone drawdown time is typically used.

Occasionally, the designer may have an alternative control, for example a manufactured treatment device, with a specified maximum flow rate but little to no water quality volume. In SLAT, outflow is assumed to occur at a constant flow rate throughout the drawdown period. \

Row 30: Drawdown Time, DDT (hrs)

Input the design drawdown time, in hours, for the control to drain from full to empty. This excludes the “lag time” when the control is full but cannot release the water. For example, a typical retention/irrigation system with a 12 hour lag time and a 72 hour total time (from end of storm event to emptying) would have a 60 hour drawdown time.

The minimum drawdown time is 48 hours. There is no maximum drawdown time, however, longer drawdown times cause decreased runoff capture efficiency. The user may iterate with drawdown time and water quality volume in order to find the best fit for their proposed site.

Row 31: Flow rate (gpm)

If the control is designed to a specific flow rate rather than a drawdown time, input the flow rate in gallons per minute.

Row 32: Treatment Rate, Ω (in/hr)

Converts the inputs from either row 32 or 33 into inches per hour. This is the drawdown rate or treatment rate of the control, and is also assumed to be the maximum application rate for the infiltration field.

Row 33: Do you already know the runoff capture efficiency?

Input Yes or No. If the user wishes to use the built-in calculator for runoff capture efficiency, leave the default value of No. If the user wishes to perform their own independent engineering analysis, such as through continuous simulation, input Yes.

Row 34: User Entered Runoff Capture Efficiency

Activates if the user input Yes in row 31. The input is expressed as a percentage, from 0 to 100 (not a fraction from 0 to 1).

Row 35: Runoff Capture Efficiency, RCE (%)

Displays, for user reference, the runoff capture efficiency (*RCE*) used in subsequent calculations. This will either be the *RCE* calculated internally by SLAT using a probabilistic methodology (see Section III), or the *RCE* input by the user, depending on the input for row 31.

If *RCE* is calculated by SLAT, it uses a modified treatment rate, Ω , which takes into account the delay after rainfall before pumping begins.

Row 37: How is effluent from SCM 1 discharged?

Input Pumped or Gravity Drained. Within the Barton Springs Zone, gravity drained can only be used for systems that use sedimentation/filtration as the first control, and where site topography allows.

Row 38: Delay after end of rainfall before discharging SCM 1 (hours)

This is based on the input for row 41 and assumes a lag time of 12 hours if the system is pumped, and 0 hours if gravity drained.

Row 41: SCM Type

From the drop-down list, select the proposed stormwater control measure that is second in series. If "Alternative" is selected, rows 71 through 77 will activate and the user will need to

input the effluent concentration later. Note that “Infiltration Field” also includes irrigation fields.

Row 42: Do you know the infiltrated or reused water quantity?

The user has two options: “Yes,” and “No; infiltrate all routed water.” For a typical analysis, the user would input “No; infiltrate all routed water.” This option assumes that the entire water quality volume from SCM 1 is infiltrated/irrigated/beneficially used. For pumped systems within the Barton Springs Zone, it is recommended that “No; infiltrate all routed water” is chosen because in that case all of the water captured by SCM 1 must be irrigated or infiltrated.

An example of a case where the user chooses “Yes” may be a rainwater harvesting system outside the Barton Springs Zone where some, but not all of the volume, is consumed by beneficial use. In this case, the user would need to independently calculate the water quality volume or percentage used or infiltrated.

If no infiltration occurs in SCM 2, then the user would choose “Yes” and input 0 in row 43.

Row 43: User-entered infiltrated water quality volume, WQV_{inf} (in)

This volume is the maximum amount of water that can be infiltrated over the drawdown period of SCM 1, expressed in inches. Though there is no storage component for infiltration, it is analogous to the “water quality volume” infiltrated.

Row 44: -OR- Percent of yearly runoff infiltrated, RCE_{inf} (%)

This input is used as an alternative to row 48 only if row 36 contains a user-entered runoff capture efficiency. The user must self-calculate and input the average annual percent of runoff that is infiltrated. For sites outside the Barton Springs Zone, the number must be less than or equal to the average annual runoff capture efficiency in row 36.

Row 45: Soil infiltration rate (in/hr)

Input the soil infiltration rate. The infiltration rate should reflect the site-specific soil permeability and is subject to approval by the plan reviewer. Per the ECM, the rate cannot exceed 0.2 in/hr.

Row 46: Ratio of drawdown time / irrigation time, for any zone

Typically this is equal to the number of irrigation zones or, if a single zone, the number of alternating irrigation periods. SLAT assumes that the number of alternating irrigation zones is 2 for systems that are pumped, and 1 for systems that are gravity drained.

Row 47: Approximate Minimum Field Area (Ac)

Displays the minimum field size needed to infiltrate or irrigate the volume of runoff modeled. The actual field size may need to be larger, for example if the irrigation rate is less than the soil infiltration rate used for the field size calculation.

Rows 53 through 59: Input effluent data for alternative SCM 1 (mg/L and CFU/100 mL)

Activates if the user input “Alternative” for row 26. The user should input the effluent concentration for each of the pollutants, and the concentrations should be supported by approved published data per in ECM 1.6.9.3.G.

While concentrations for the metals lead (Pb) and zinc (Zn) are typically expressed in $\mu\text{g/L}$ in the literature, the concentrations should be input in mg/L for the tool.

Rows 62 through 68: Input effluent data for alternative SCM 2 (mg/L and CFU/100 mL)

Activates if the user input “Alternative” for row 45. The user should input the effluent concentration for each of the pollutants, and the concentrations should be supported by approved published data per in ECM 1.6.9.3.G.

While concentrations for the metals lead (Pb) and zinc (Zn) are typically expressed in $\mu\text{g/L}$ in the literature, the concentrations should be input in mg/L in SLAT 2.0.

VI. EXAMPLE PROJECTS

C. Two Drainage Areas Within Barton Springs Zone

A developer is planning a 20 acre commercial site within the Barton Springs Zone. The existing site is undeveloped, and the proposed site has a net impervious cover of 20%. The developer wishes to incorporate rainwater harvesting and reuse for a large building to comply with beneficial use requirements. The rest of the parking lot will be treated by a sedimentation/filtration basin, then an infiltration field. The developer needs to size the stormwater control measures (SCMs) such that the developed pollutant loads are no greater than baseline loads. The proposed site layout is shown below in Figure 4.

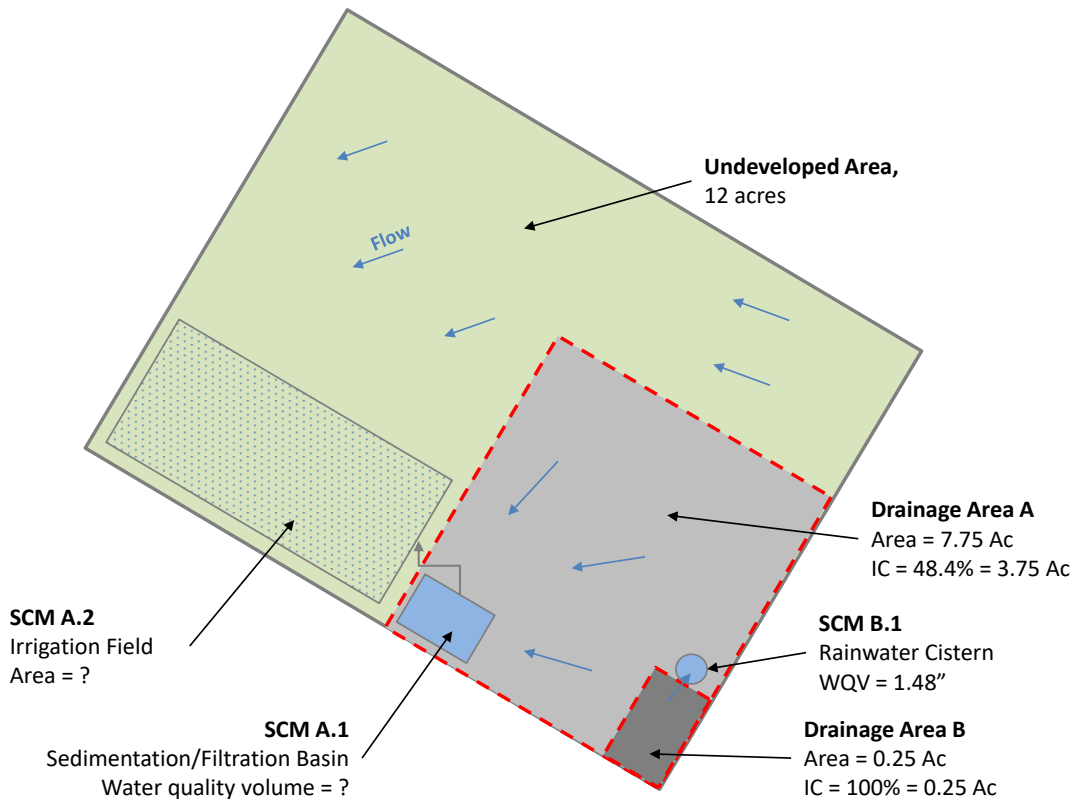

Figure 4: Simplified layout of example site with two drainage areas

The designer begins by clicking the Restore Defaults button and fills in the general site information. When they select “2” in row 15 for the number of drainage areas, the columns for Drainage Area A and Drainage Area B become highlighted. The designer first fills out the Drainage Area A column, progressing from top to bottom, then goes back to complete the Drainage Area B column.

| Step 1: Input site characteristics in yellow highlighted | | |
|--|---------------------------------|---------------------------------|
| User Manual Example Site 1 | Editor Name | |
| Is your site within the Barton Springs Zone (BSZ)? | Yes | |
| How many drainage areas, n_{max} , does your site have? | 2 | |
| | Drainage Area A | Drainage Area B |
| Drainage area to the control, A_i (acres) | 7.75 | 0.25 |
| Base impervious cover of the drainage area, IC_b (%) | 0.0 | 0.0 |
| Developed impervious cover of the drainage area, IC_D (%) | 48.4 | 100.0 |
| Step 2: Input SCM characteristics in yellow highlighted | | |
| | Drainage Area A | Drainage Area B |
| | SCM A1 | SCM B1 |
| SCM Type | Sedimentation/Filtration | Rainwater Harvesting |
| Is SCM 1 off-line? | Yes (Off-Line) | Yes (Off-Line) |
| What is the Water Quality Volume, WQV (inches) [aka Capture Depth] | 1.5 | 1.48 |
| Minimum water quality volume allowed (in) | 0.78 | 1.30 |
| SCM 1 Actual Volume (ft ³) | 42199 | 1343 |
| Do you know the drawdown time or the flow rate? | Drawdown Time | Drawdown Time |
| Drawdown Time, DDT (hrs) [tot. time to empty full SCM] | 48 | 60 |
| Flow Rate (gpm) [use only for "alternative" controls] | | |
| Treatment Rate, Ω (in/hr) | 0.031 | 0.025 |
| Do you already know the runoff capture efficiency? | No | No |
| User Entered Runoff Capture Efficiency, RCE (%) | | |
| Runoff Capture Efficiency, RCE (%) | 97.9% | 90.3% |
| Conveyance | | |
| How is effluent from SCM 1 discharged? | Gravity Drained | Pumped |
| Delay after end of rainfall before discharging SCM 1 (hrs) | 0 | 15 |
| SCM 2 (Second in Series) | SCM A2 | SCM B2 |
| SCM Type | Infiltration Field | Beneficial Use |
| Do you know the infiltrated or reused water quantity? | No; infiltrate all routed water | No; infiltrate all routed water |
| User-entered infilt. water quality volume, WQV_{inf} (in) | | |
| -OR- Percent of yearly runoff infiltrated, RCE_{inf} (%) | | |
| Soil infiltration rate (in/hr) | 0.1 | |
| Ratio of drawdown time / irrigation time, for any zone | 1 | |
| Approximate Minimum Field Area (Ac) | 4.84 | |

Tests showed that the infiltration rate is 0.1 in/hr. For the proposed system in Drainage Area A, at least 4.84 acres are needed to irrigate the full volume.

11 **Step 1: Input site characteristics in yellow highlights**

12 User Manual Example Site 1 Editor Name

13

14 Is your site within the Barton Springs Zone (BSZ)? **Yes**

15 How many drainage areas, n_{max} , does your site have? **2**

16 **Drainage Area A** **Drainage Area B**

17 Drainage area to the control, A_n (acres) **7.75** **0.25**

18 Base impervious cover of the drainage area, IC_b (%) 0.0 0.0

19 Developed impervious cover of the drainage area, IC_D (%) **48.4** **100.0**

20

21 **Step 2: Input SCM characteristics in yellow highlights**

22 **Drainage Area A** **Drainage Area B**

23 **SCM A1** **SCM B1**

24 **SCM 1 (First in Series)** **SCM Type** Sedimentation/Filtration Rainwater Harvesting

25 Is SCM 1 off-line? Yes (Off-Line) Yes (Off-Line)

26 **What is the Water Quality Volume, WQV (inches) [aka Capture Depth]** **1.5** **1.48**

27 *Minimum water quality volume allowed (in)* 0.78 1.30

28 SCM 1 Actual Volume (ft³) 42199 1343

29 Do you know the **drawdown time** or the **flow rate**? **Drawdown Time** **Drawdown Time**

30 **Drawdown Time, DDT (hrs)** [tot. time to empty full SCM] **48** **60**

31 **Flow Rate (gpm)** [use only for "alternative" controls]

32 Treatment Rate, Ω (in/hr) 0.031 0.025

33 Do you already know the **runoff capture efficiency**? **No** **No**

34 User Entered Runoff Capture Efficiency, RCE (%)

35 Runoff Capture Efficiency, RCE (%) **97.9%** **90.3%**

36 **Conveyance**

37 How is effluent from SCM 1 discharged? **Gravity Drained** **Pumped**

38 Delay after end of rainfall before discharging SCM 1 (hrs) 0 12

39

40 **SCM 2 (Second in Series)** **SCM A2** **SCM B2**

41 **SCM Type** Infiltration Field Beneficial Use

42 Do you know the infiltrated or reused water quantity? **No; infiltrate all routed water** **No; infiltrate all routed water**

43 User-entered infiltr. water quality volume, WQV_{inf} (in)

44 -OR- Percent of yearly runoff infiltrated, RCE_{inf} (%)

45 Soil infiltration rate (in/hr) 0.1

46 Ratio of drawdown time / irrigation time, for any zone 1

47 Approximate Minimum Field Area (Ac) 4.84

The designer then moves to the column for Drainage Area B and fills out the appropriate drainage area information. The impervious cover for the quarter-acre roof is 100%. The designer has selected a 10,000 gallon (1337 ft³) cistern. Based on the 0.25-acre drainage area, they calculate that this equates to a 1.48" water quality volume. The cistern will be plumbed to be off-line. The cistern will supply landscape irrigation. Based on the irrigation schedule, the cistern, when full, will draw down in 60 hours. The designer lets SLAT calculate the runoff capture efficiency, which is 90.3%. The cistern will be pumped and must comply with the 12 hour lag time requirement. All of the captured water will be used for irrigation of the landscaped area, which is considered beneficial use.

Once the user inputs all of the above information, they scroll down to the bottom of the worksheet and click the "View Full Results" button. This button takes them to the "2. RESULTS" worksheet, which is shown in Figure 5. The design meets the SOS ordinance load requirements. Considering both drainage areas from the site, the load for all pollutants is less than the existing load, and therefore the load equivalency factor (LEF) is less than 1.0 for all pollutants.

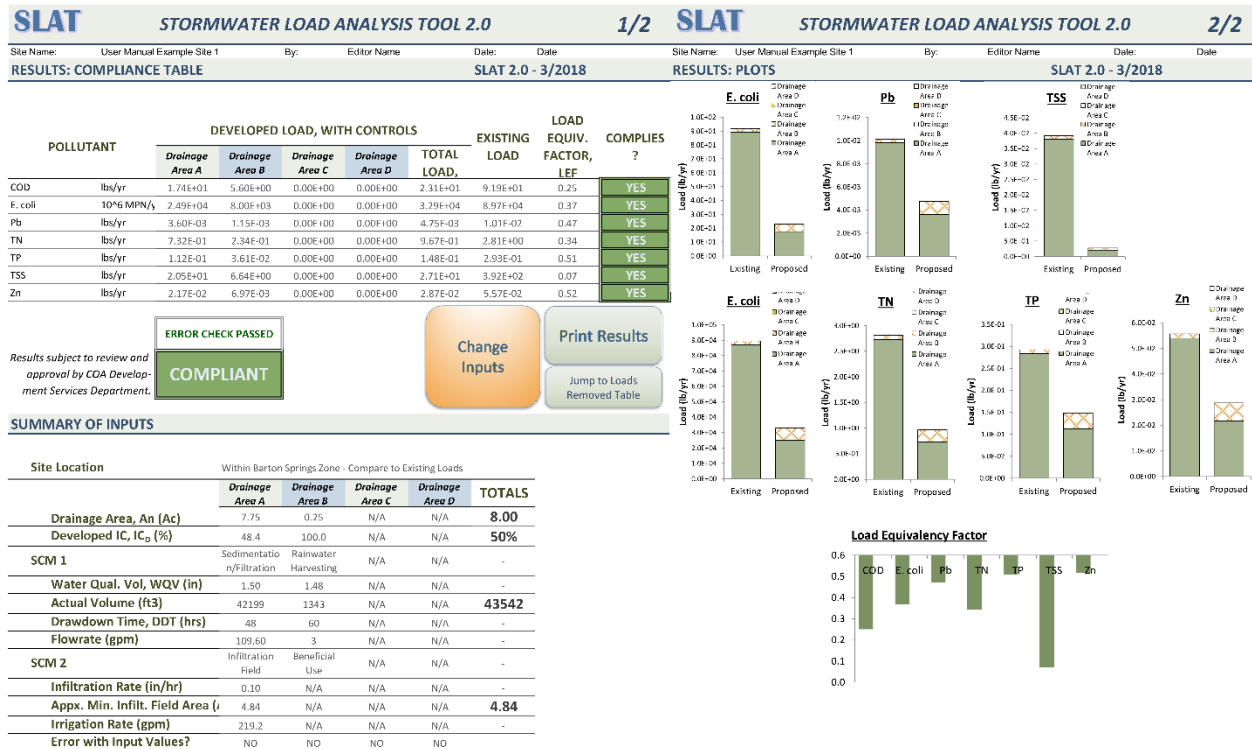

Figure 5: Worksheet “2. RESULTS” shows that the proposed design complies with SOS requirements. Project parameters and loads are on the left, with pollutant plots on the right.

At this point, the designer could stop because their proposed design complies. However, they may wish to modify and optimize the design. The remainder of this example shows how to iterate on the design while still meeting load requirements.

The designer chooses to decrease the size of the infiltration field for Drainage Area A. To do so, they first increase the drawdown time of SCM 1 to 60 hours (row 30), which has the effect of decreasing the hydraulic loading rate to the infiltration field. The change causes the minimum infiltration field size to decrease from 4.84 acres to 3.88 acres (row 47). The Results worksheet shows that while the load equivalency factors have increased, the design is still compliant.

The designer then decides to shrink the size of the sedimentation/filtration basin by decreasing the water quality volume from 1.50 inches to 1.0 inches (row 26). However, the Results worksheet reveals that the proposed design is no longer compliant.

| POLLUTANT | | DEVELOPED LOAD, WITH CONTROLS | | | | TOTAL LOAD, | EXISTING LOAD | LOAD EQUIV. FACTOR, LEF | COMPLIES? |
|-----------|-----------------------|-------------------------------|-----------------|-----------------|-----------------|-------------|---------------|-------------------------|-----------|
| | | Drainage Area A | Drainage Area B | Drainage Area C | Drainage Area D | | | | |
| BOD | lbs/yr | 5.36E+01 | 5.60E+00 | 0.00E+00 | 0.00E+00 | 5.92E+01 | 9.19E+01 | 0.64 | YES |
| E. coli | 10 ⁶ MPN/y | 7.48E+04 | 8.00E+03 | 0.00E+00 | 0.00E+00 | 8.28E+04 | 8.97E+04 | 0.92 | YES |
| pb | lbs/yr | 1.09E-02 | 1.15E-03 | 0.00E+00 | 0.00E+00 | 1.21E-02 | 1.01E-02 | 1.19 | NO |
| TN | lbs/yr | 1.99E+00 | 2.34E-01 | 0.00E+00 | 0.00E+00 | 2.23E+00 | 2.81E+00 | 0.79 | YES |
| TP | lbs/yr | 3.38E-01 | 3.61E-02 | 0.00E+00 | 0.00E+00 | 3.74E-01 | 2.93E-01 | 1.28 | NO |
| TSS | lbs/yr | 7.78E+01 | 6.64E+00 | 0.00E+00 | 0.00E+00 | 8.45E+01 | 3.92E+02 | 0.22 | YES |
| Zn | lbs/yr | 6.45E-02 | 6.97E-03 | 0.00E+00 | 0.00E+00 | 7.15E-02 | 5.57E-02 | 1.28 | NO |

Results subject to review and approval by COA Development Services Department.

ERROR CHECK PASSED

NOT COMPLIANT

Change Inputs

Print Results

Jump to Loads Removed Table

Figure 6: Interim results during iteration on the water quality volume are not compliant.

The designer continues to revise the water quality volume in row 26, and settles on a water quality volume of 1.17 inches for the basin. Now zinc has the highest load equivalency factor (LEF) of all pollutants at 0.99, which is still less than 1.0, so the proposed design is compliant.

| Step 1: Input site characteristics in yellow highlighted | | |
|--|--|--|
| 11 | | |
| 12 | User Manual Example Site 1 | Editor Name |
| 13 | | |
| 14 | Is your site within the Barton Springs Zone (BSZ)? | Yes |
| 15 | How many drainage areas, n_{max} , does your site have? | 2 |
| 16 | | Drainage Area A Drainage Area B |
| 17 | Drainage area to the control, A_n (acres) | 7.75 0.25 |
| 18 | Base impervious cover of the drainage area, IC_b (%) | 0.0 0.0 |
| 19 | Developed impervious cover of the drainage area, IC_D (%) | 48.4 100.0 |
| 20 | | |
| Step 2: Input SCM characteristics in yellow highlighted | | |
| 21 | | |
| 22 | | Drainage Area A Drainage Area B |
| 23 | SCM 1 (First in Series) | SCM A1 SCM B1 |
| 24 | SCM Type | Sedimentation/Filtration Rainwater Harvesting |
| 25 | Is SCM 1 off-line? | Yes (Off-Line) Yes (Off-Line) |
| 26 | What is the Water Quality Volume, WQV (inches) [aka Capture Depth] | 1.17 1.48 |
| 27 | Minimum water quality volume allowed (in) | 0.78 1.30 |
| 28 | SCM 1 Actual Volume (ft ³) | 32915 1343 |
| 29 | Do you know the drawdown time or the flow rate? | Drawdown Time Drawdown Time |
| 30 | Drawdown Time, DDT (hrs) [tot. time to empty full SCM] | 60 60 |
| 31 | Flow Rate (gpm) [use only for "alternative" controls] | |
| 32 | Treatment Rate, Ω (in/hr) | 0.020 0.025 |
| 33 | Do you already know the runoff capture efficiency? | No No |
| 34 | User Entered Runoff Capture Efficiency, RCE (%) | |
| 35 | Runoff Capture Efficiency, RCE (%) | 95.9% 90.3% |
| 36 | Conveyance | |
| 37 | How is effluent from SCM 1 discharged? | Gravity Drained Pumped |
| 38 | Delay after end of rainfall before discharging SCM 1 (hrs) | 0 12 |
| 39 | | |
| 40 | SCM 2 (Second in Series) | SCM A2 SCM B2 |
| 41 | SCM Type | Infiltration Field Beneficial Use |
| 42 | Do you know the infiltrated or reused water quantity? | No; infiltrate all routed water No; infiltrate all routed water |
| 43 | User-entered infilt. water quality volume, WQV_{inf} (in) | |
| 44 | -OR- Percent of yearly runoff infiltrated, RCE_{inf} (%) | |
| 45 | Soil infiltration rate (in/hr) | 0.1 |
| 46 | Ratio of drawdown time / irrigation time, for any zone | 1 |
| 47 | Approximate Minimum Field Area (Ac) | 3.02 |

Figure 7: Sheet “1. ENTER DATA” with final modified drawdown time and water quality volume for Drainage Area 1

| POLLUTANT | | DEVELOPED LOAD, WITH CONTROLS | | | | TOTAL LOAD, | EXISTING LOAD | LOAD EQUIV. FACTOR, LEF | COMPLIES? |
|-----------|-----------------------|-------------------------------|-----------------|-----------------|-----------------|-------------|---------------|-------------------------|-----------|
| | | Drainage Area A | Drainage Area B | Drainage Area C | Drainage Area D | | | | |
| COD | lbs/yr | 3.97E+01 | 5.60E+00 | 0.00E+00 | 0.00E+00 | 4.53E+01 | 9.19E+01 | 0.49 | YES |
| E. coli | 10 ⁶ MPN/y | 5.59E+04 | 8.00E+03 | 0.00E+00 | 0.00E+00 | 6.39E+04 | 8.97E+04 | 0.71 | YES |
| Pb | lbs/yr | 8.13E-03 | 1.15E-03 | 0.00E+00 | 0.00E+00 | 9.29E-03 | 1.01E-02 | 0.92 | YES |
| TN | lbs/yr | 1.54E+00 | 2.34E-01 | 0.00E+00 | 0.00E+00 | 1.77E+00 | 2.81E+00 | 0.63 | YES |
| TP | lbs/yr | 2.53E-01 | 3.61E-02 | 0.00E+00 | 0.00E+00 | 2.89E-01 | 2.93E-01 | 0.99 | YES |
| TSS | lbs/yr | 5.37E+01 | 6.64E+00 | 0.00E+00 | 0.00E+00 | 6.03E+01 | 3.92E+02 | 0.15 | YES |
| Zn | lbs/yr | 4.84E-02 | 6.97E-03 | 0.00E+00 | 0.00E+00 | 5.53E-02 | 5.57E-02 | 0.99 | YES |

Results subject to review and approval by COA Development Services Department.

ERROR CHECK PASSED

COMPLIANT

Change
Inputs

Print Results

Jump to Loads
Removed Table

Figure 8: Sheet “2. RESULTS” shows that the updated proposed design complies with SOS load requirements.

The designer then prints worksheets “1. ENTER DATA” and “2. RESULTS” as evidence of the engineering analysis which can be submitted to the water quality reviewer.

D. Alternative Controls Outside Barton Springs Zone

A landowner proposes to build an apartment building in an urban area outside of the Barton Springs Zone. The site is 1.5 acres and the proposed impervious cover is 78%. The contours of the site and location of the roof’s gutters delineate the site into two drainage areas. Due to limited space, the owner wishes to use a combination of an inlet treatment device and a rain garden, rather than the standard sedimentation/filtration system. The engineer needs to demonstrate that the proposed alternative SCMs will be equivalent in load to a sedimentation/filtration basin that is sized according to ECM criteria. The proposed site layout is shown below in Figure 9.

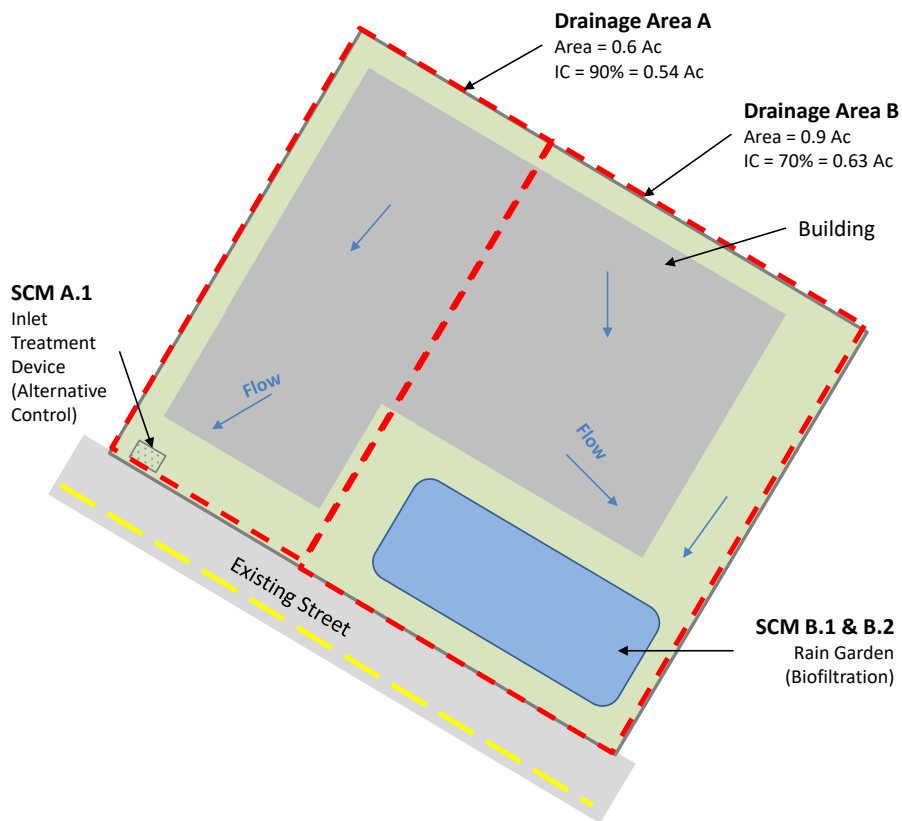

Figure 9: Simplified layout of example site with two drainage areas

The engineer opens SLAT, restores defaults, and enters the general site information.

Step 1: Input site characteristics in yellow highlighted cells

| | | |
|---|-----------------|-----------------|
| User Manual Example Site B | Editor Name | |
| Is your site within the Barton Springs Zone (BSZ)? | No | |
| How many drainage areas, n_{max} , does your site have? | 2 | |
| | Drainage Area A | Drainage Area B |
| Drainage area to the control, A_i (acres) | 0.60 | 1.00 |
| Base impervious cover of the drainage area, IC_B (%) | 0.0 | 0.0 |
| Developed impervious cover of the drainage area, IC_D (%) | 90.0 | 50.0 |

Step 2: Input SCM characteristics in yellow highlighted cells

| | Drainage Area A | Drainage Area B |
|---|-----------------|---------------------------------|
| SCM 1 (First in Series) | SCM A1 | SCM B1 |
| SCM Type | Alternative | Retention Basin |
| Is SCM 1 off-line? | No (On-Line) | Yes (Off-Line) |
| What is the Water Quality Volume, WQV (inches) [aka Capture Depth] | 0 | 2.5 |
| Minimum water quality volume allowed (in) | 0.00 | 0.00 |
| SCM 1 Actual Volume (ft ³) | 0 | 907 |
| Do you know the drawdown time or the flow rate? | Flow Rate | Drawdown Time |
| Drawdown Time, DDT (hrs) [tot. time to empty full SCM 1] | | 60 |
| Flow Rate (gpm) [use only for "alternative" controls] | 50.0 | |
| Treatment Rate, Ω (in/hr) | 0.184 | 0.007 |
| Do you already know the runoff capture efficiency? | No | No |
| User Entered Runoff Capture Efficiency, RCE (%) | | |
| Runoff Capture Efficiency, RCE (%) | 78.9% | 98.1% |
| Conveyance | | |
| How is effluent from SCM 1 discharged? | Gravity Drained | Pumped |
| Delay after end of rainfall before discharging SCM 1 (hrs) | 0 | 12 |
| SCM 2 (Second in Series) | SCM A2 | SCM B2 |
| SCM Type | | Infiltration Field |
| Do you know the infiltrated or reused water quantity? | | No; infiltrate all routed water |
| User-entered infiltr. water quality volume, WQV _{inf} (in) | | |
| -OR- Percent of yearly runoff infiltrated, RCE _{inf} (%) | | |
| Soil infiltration rate (in/hr) | | 0.1 |
| Ratio of drawdown time / irrigation time, for any zone | | 2 |
| Approximate Minimum Field Area (Ac) | | 0.83 |

Step 3: Input Effluent Data for Alternative SCMs

| Pollutant | Units | Drainage Area A |
|-----------|-----------|-----------------|
| | | Alternative |
| COD | mg/L | 40 |
| E. coli | CFU/100mL | 10000 |
| Pb | mg/L | 0.008 |
| TN | mg/L | 1.4 |
| TP | mg/L | 0.2 |
| TSS | mg/L | 20 |
| Zn | mg/L | 0.04 |

The site is outside the Barton Springs Zone, so the proposed loads will be compared to sed/fil loads. There are 2 drainage areas.

Drainage Area A will be the portion of the building and site that drains directly to the inlet treatment device. Its area, existing, and proposed impervious cover are entered.

This is an alternative control. There is no splitter, so it is "on-line."

The proposed device is a flow-through system that does not provide volume capture.

The engineer expects a 50 gpm flow rate during storms (they separately determined that this size is also DCM compliant).

SLAT calculates the runoff capture efficiency, 78.9%.

The device is not pumped.

There is no second control; effluent goes to the storm sewer.

Effluent concentrations came from published monitoring data which has been

approved by the city in accordance with the ECM.

| | | | |
|----|--|-----------------|---------------------------------|
| 12 | User Manual Example Site B | Editor Name | |
| 13 | | | |
| 14 | Is your site within the Barton Springs Zone (BSZ)? | No | |
| 15 | How many drainage areas, n_{max} , does your site have? | 2 | |
| 16 | | Drainage Area A | Drainage Area B |
| 17 | Drainage area to the control, A_c (acres) | 0.60 | 0.90 |
| 18 | Base impervious cover of the drainage area, IC_b (%) | 0.0 | 0.0 |
| 19 | Developed impervious cover of the drainage area, IC_d (%) | 90.0 | 70.0 |
| 20 | | | |
| 21 | Step 2: Input SCM characteristics in yellow highlighted | | |
| 22 | | Drainage Area A | Drainage Area B |
| 23 | SCM 1 (First in Series) | SCM A1 | SCM B1 |
| 24 | SCM Type | Alternative | Biofiltration |
| 25 | Is SCM 1 off-line? | No (On-Line) | Yes (Off-Line) |
| 26 | What is the Water Quality Volume, WQV (inches) [aka Capture Depth] | 0 | 2.3 |
| 27 | Minimum water quality volume allowed (in) | 0.00 | 0.00 |
| 28 | SCM 1 Actual Volume (ft ³) | 0 | 7514 |
| 29 | Do you know the drawdown time or the flow rate? | Flow Rate | Drawdown Time |
| 30 | Drawdown Time, DDT (hrs) [tot. time to empty full SCM 1] | | 48 |
| 31 | Flow Rate (gpm) [use only for "alternative" controls] | 50.0 | |
| 32 | Treatment Rate, Ω (in/hr) | 0.184 | 0.048 |
| 33 | Do you already know the runoff capture efficiency? | No | No |
| 34 | User Entered Runoff Capture Efficiency, RCE (%) | | |
| 35 | Runoff Capture Efficiency, RCE (%) | 78.9% | 98.1% |
| 36 | Conveyance | | |
| 37 | How is effluent from SCM 1 discharged? | Gravity Drained | Gravity Drained |
| 38 | Delay after end of rainfall before discharging SCM 1 (hrs) | 0 | 0 |
| 39 | | | |
| 40 | SCM 2 (Second in Series) | SCM A2 | SCM B2 |
| 41 | SCM Type | | Infiltration Field |
| 42 | Do you know the infiltrated or reused water quantity? | | No; infiltrate all routed water |
| 43 | User-entered infiltr. water quality volume, WQV_{inf} (in) | | |
| 44 | -OR- Percent of yearly runoff infiltrated, RCE_{inf} (%) | | |
| 45 | Soil infiltration rate (in/hr) | | 0.15 |
| 46 | Ratio of drawdown time / irrigation time, for any zone | | 1 |
| 47 | Approximate Minimum Field Area (Ac) | | 0.29 |
| .. | | | |

Moving to Drainage Area B, the engineer inputs the drainage area and impervious covers.

They are proposing an infiltration rain garden for this control, which will be modeled as off-line biofiltration. The water quality volume of 2.3 inches considers the landscaped area that the site can accommodate.

Consistent with ECM criteria, the full rain garden empties in 48 hours.

An infiltration rain garden, it behaves the same as a gravity drained system.

Even though there is no physically separate infiltration field, infiltration occurs through the bed of the rain garden.

The engineer enters the anticipated infiltration rate, which already includes a factor of safety.

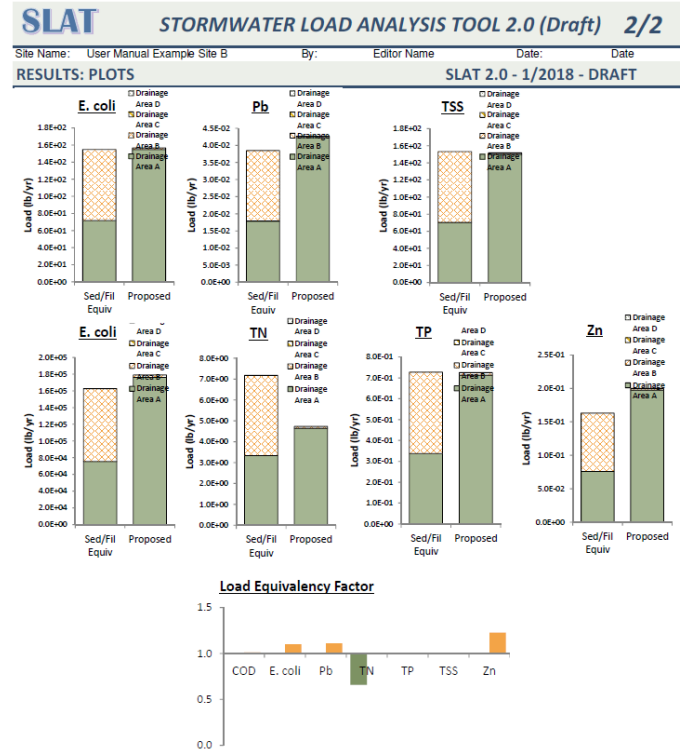
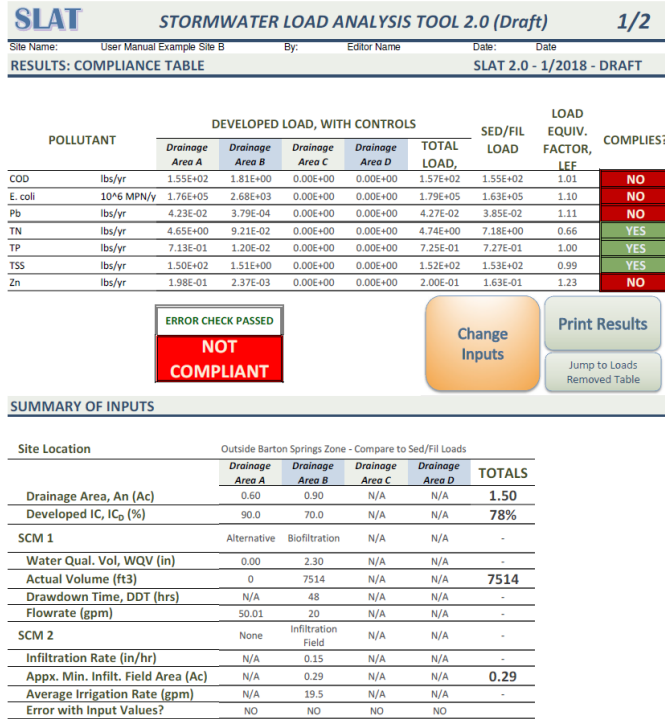

Figure 10: The printed results from Sheet 2 show that the site, as modeled, is not compliant.

As initially modeled, the site is not compliant. So, the engineer increases the flow rate by trying the next-biggest inlet treatment device offered by the manufacturer, which is 120 gpm (row 31). Now, the site is compliant. A glance at the results sheet shows that zinc is the most conservative pollutant, with a load equivalency factor of 1.0.

| Step 1: Input site characteristics in yellow highlighted cells | | | |
|--|--|-----------------|---------------------------------|
| 11 | | | |
| 12 | User Manual Example Site B | Editor Name | Date |
| 13 | | | |
| 14 | Is your site within the Barton Springs Zone (BSZ)? | No | |
| 15 | How many drainage areas, n_{drain} , does your site have? | 2 | |
| 16 | | Drainage Area A | Drainage Area B |
| 17 | Drainage area to the control, A_c (acres) | 0.60 | 0.90 |
| 18 | Base impervious cover of the drainage area, IC_b (%) | 0.0 | 0.0 |
| 19 | Developed impervious cover of the drainage area, IC_d (%) | 90.0 | 70.0 |
| 20 | | | |
| Step 2: Input SCM characteristics in yellow highlighted cells | | | |
| 21 | | | |
| 22 | | Drainage Area A | Drainage Area B |
| 23 | SCM 1 (First in Series) | SCMA1 | SCMB1 |
| 24 | SCM Type | Alternative | Biofiltration |
| 25 | Is SCM 1 off-line? | No (On-Line) | Yes (Off-Line) |
| 26 | What is the Water Quality Volume, WQV (inches) [aka Capture Depth] | 0 | 2.3 |
| 27 | Minimum water quality volume allowed (in) | 0.00 | 0.00 |
| 28 | SCM 1 Actual Volume (ft ³) | 0 | 7534 |
| 29 | Do you know the drawdown time or the flow rate? | Flow Rate | Drawdown Time |
| 30 | Drawdown Time, DDT (hrs) [tot. time to empty full SCM 1] | | 48 |
| 31 | Flow Rate (gpm) [use only for "alternative" controls] | 120.0 | |
| 32 | Treatment Rate, Ω (in/hr) | 0.442 | 0.048 |
| 33 | Do you already know the runoff capture efficiency? | No | No |
| 34 | User Entered Runoff Capture Efficiency, RCE (%) | | |
| 35 | Runoff Capture Efficiency, RCE (%) | 89.8% | 98.1% |
| 36 | Conveyance | | |
| 37 | How is effluent from SCM 1 discharged? | Gravity Drained | Gravity Drained |
| 38 | Delay after end of rainfall before discharging SCM 1 (hrs) | 0 | 0 |
| 39 | | | |
| 40 | SCM 2 (Second in Series) | SCMA2 | SCMB2 |
| 41 | SCM Type | | Infiltration Field |
| 42 | Do you know the infiltrated or reused water quantity? | | No; infiltrate all routed water |
| 43 | User-entered infil. water quality volume, WQV_{inf} (in) | | |
| 44 | -OR- Percent of yearly runoff infiltrated, RCE_{inf} (%) | | |
| 45 | Soil infiltration rate (in/hr) | | 0.15 |
| 46 | Ratio of drawdown time / irrigation time, for any zone | | 1 |
| 47 | Approximate Minimum Field Area (Ac) | | 0.29 |
| 48 | | | |
| Step 3: Input Effluent Data for Alternative SCMs | | | |
| 49 | | | |
| 50 | | Drainage Area A | |
| 51 | | Alternative | |
| 52 | Pollutant | Units | |
| 53 | COD | mg/L | 40 |
| 54 | E. coli | CFU/100ml | 10000 |
| 55 | Pb | mg/L | 0.008 |
| 56 | TN | mg/L | 1.4 |
| 57 | TP | mg/L | 0.2 |
| 58 | TSS | mg/L | 20 |
| 59 | Zn | mg/L | 0.04 |
| 60 | | | |
| 61 | Pollutant | Units | |
| 62 | COD | mg/L | |
| 63 | E. coli | CFU/100ml | |
| 64 | Pb | mg/L | |
| 65 | TN | mg/L | |
| 66 | TP | mg/L | |
| 67 | TSS | mg/L | |
| 68 | Zn | mg/L | |
| 69 | | | |

Figure 11: Sheet "1. ENTER DATA" with final modified flow rate for SCM A.1

| Site Name: | | User Manual Example Site B | | By: | | Editor Name | | Date: | | Date | |
|---------------------------|-----------------------|-------------------------------|-----------------|-----------------|-----------------|-------------|--------------|---------------------------|-----------|------|--|
| RESULTS: COMPLIANCE TABLE | | | | | | | | SLAT 2.0 - 1/2018 - DRAFT | | | |
| POLLUTANT | | DEVELOPED LOAD, WITH CONTROLS | | | | TOTAL LOAD, | SED/FIL LOAD | LOAD EQUIV. FACTOR, IFF | COMPLIES? | | |
| | | Drainage Area A | Drainage Area B | Drainage Area C | Drainage Area D | | | | | | |
| COD | lbs/yr | 1.36E+02 | 1.81E+00 | 0.00E+00 | 0.00E+00 | 1.38E+02 | 1.55E+02 | 0.89 | YES | | |
| E. coli | 10 ⁶ MPN/y | 1.54E+05 | 2.68E+03 | 0.00E+00 | 0.00E+00 | 1.57E+05 | 1.63E+05 | 0.97 | YES | | |
| Pb | lbs/yr | 3.26E-02 | 3.79E-04 | 0.00E+00 | 0.00E+00 | 3.30E-02 | 3.85E-02 | 0.86 | YES | | |
| TN | lbs/yr | 4.38E+00 | 9.21E-02 | 0.00E+00 | 0.00E+00 | 4.47E+00 | 7.18E+00 | 0.62 | YES | | |
| TP | lbs/yr | 6.49E-01 | 1.20E-02 | 0.00E+00 | 0.00E+00 | 6.61E-01 | 7.27E-01 | 0.91 | YES | | |
| TSS | lbs/yr | 1.03E+02 | 1.51E+00 | 0.00E+00 | 0.00E+00 | 1.04E+02 | 1.53E+02 | 0.68 | YES | | |
| Zn | lbs/yr | 1.56E-01 | 2.37E-03 | 0.00E+00 | 0.00E+00 | 1.59E-01 | 1.63E-01 | 0.97 | YES | | |

ERROR CHECK PASSED

COMPLIANT

Change Inputs

Print Results

Jump to Loads Removed Table

Figure 12: Sheet “2. RESULTS” showing that proposed design now complies with SOS load requirements.

VII. REFERENCES

Adams, B. J., & Papa, F. (2000). *Urban Stormwater Management Planning with Analytical Probabilistic Models*. New York: John Wiley & Sons, Inc.

California Department of Transportation. (2005). *First Flush Phenomenon Characterization*. CTSW-RT-05-73-02.6.

City of Austin Watershed Protection Department. (2013). *Impacts of Stormwater Control Measures on Water Quality in Austin, TX*. (Report Number CM-13-02). Austin, Texas.

City of Austin Watershed Protection Department. (2009). *Stormwater Runoff Quality and Quantity from Small Watersheds in Austin, TX: Updated through 2008*. (Report Number CM-09-03). Austin, Texas.

City of Austin Watershed Protection Department. (2014). *BMP Bypass Pollutant Concentrations Based on Storm Runoff Concentrations*. (Report Number SR-14-10). Austin, Texas.

City of Austin Watershed Protection Department. (2018). *Updating the City of Austin Rainfall Period of Record Timeseries and Statistics*. (Report Number SR-18-05). Austin, Texas.

APPENDIX A: SLAT DEFAULT INPUT VALUES

| Row | Description | Value |
|-------|---|---------------------------------|
| 14 | Is your site within the Barton Springs Zone? | Yes |
| 15 | How many drainage areas, n_{max} , does your site have? | 1 |
| 17 | Drainage Area to the control, A_n (acres) | 1.00 |
| 18 | Base impervious cover of the drainage area, IC_B (%) | 0.0 |
| 19 | Developed impervious cover of the drainage area, IC_D (%) | 50.0 |
| 24 | SCM Type | Retention Basin |
| 25 | Is SCM 1 off-line? | Yes (Off-Line) |
| 26 | What is the water quality volume, WQV (inches) [aka Capture Depth]? | 2.50 |
| 29 | Do you know the drawdown time or the flow rate? | Drawdown Time |
| 30 | Drawdown Time (hours) | 60 |
| 31 | Flow Rate (gpm) | 15.1 |
| 33 | Do you already know the runoff capture efficiency? | No |
| 34 | User Entered Runoff Capture Efficiency (%) | 0.0 |
| 37 | How is effluent from SCM 1 discharged? | Pumped |
| 41 | SCM Type | Infiltration Field |
| 42 | Do you already know the infiltrated or reused water quantity? | No; infiltrate all routed water |
| 43 | User-entered infilt. Water quality volume, WQV_{inf} (in) | 2.50 |
| 44 | -OR- Percent of yearly runoff infiltrated, RCE_{inf} (%) | 0.0 |
| 45 | Soil infiltration rate (in/hr) | 0.1 |
| 53-59 | Input Effluent Data for Alternative SCMs [SCM 1] | Blank |
| 62-68 | Input Effluent Data for Alternative SCMs [SCM 2] | Blank |

APPENDIX B: UPDATES TO SLAT

UPDATES TO SLAT IN VERSION 2.0

The following major revisions have been made to SLAT Version 2.0, compared to Version 1.1.

1. Add better error checking. Add option to turn error checking on or off (unprotected version only). If error checking is on, tool will not “pass” a project that has errors.
2. Added ability to back-calculate water quality volume based on a given user-input runoff capture efficiency.
3. Rows 43 & 44: if the user input a self-calculated runoff capture efficiency for SCM 1, the user should input a self-calculated runoff capture efficiency for SCM 2. Otherwise, user inputs infiltrated/reused water quality volume for SCM 2.
4. Updated Sheet 3 calculations.
5. Removed total organic carbon (TOC) from pollutant list for consistency with 2017 COA code changes. These changes are anticipated to be implemented in the ECM in 2018.
6. Removed former row 42. SLAT now automatically calculates the time delay based on other user inputs.
7. Removed former row 46. SLAT no longer allows flow from SCM 1 to SCM 2 to split. If SCM 2 exists, assume that all effluent from SCM 1 is routed to SCM 2.
8. Removed former row 51. SLAT now automatically calculates the number of application zones based on other user inputs (now row 46).
9. Removed former row 53 (total application time)
10. Removed former rows 54 & 55 on Sheet 1; no longer allow user to input infiltration field area. Instead, tool simply calculates the minimum field area.
11. Removed former row 48 which asked if SCM 2 reduces water quality volume due to redundancy with other cells.
12. Updated default inputs
13. Updated the rainfall statistics based on 2004-2013 Camp Mabry rainfall data published in the 2018 Report (SR-18-05, *Updating the City of Austin Rainfall Period of Record Timeseries and Statistics*)

UPDATES TO SLAT IN VERSION 2.1

1. Updated the SLAT model to use peak application rate rather than average application rate to calculate irrigation field size.

