

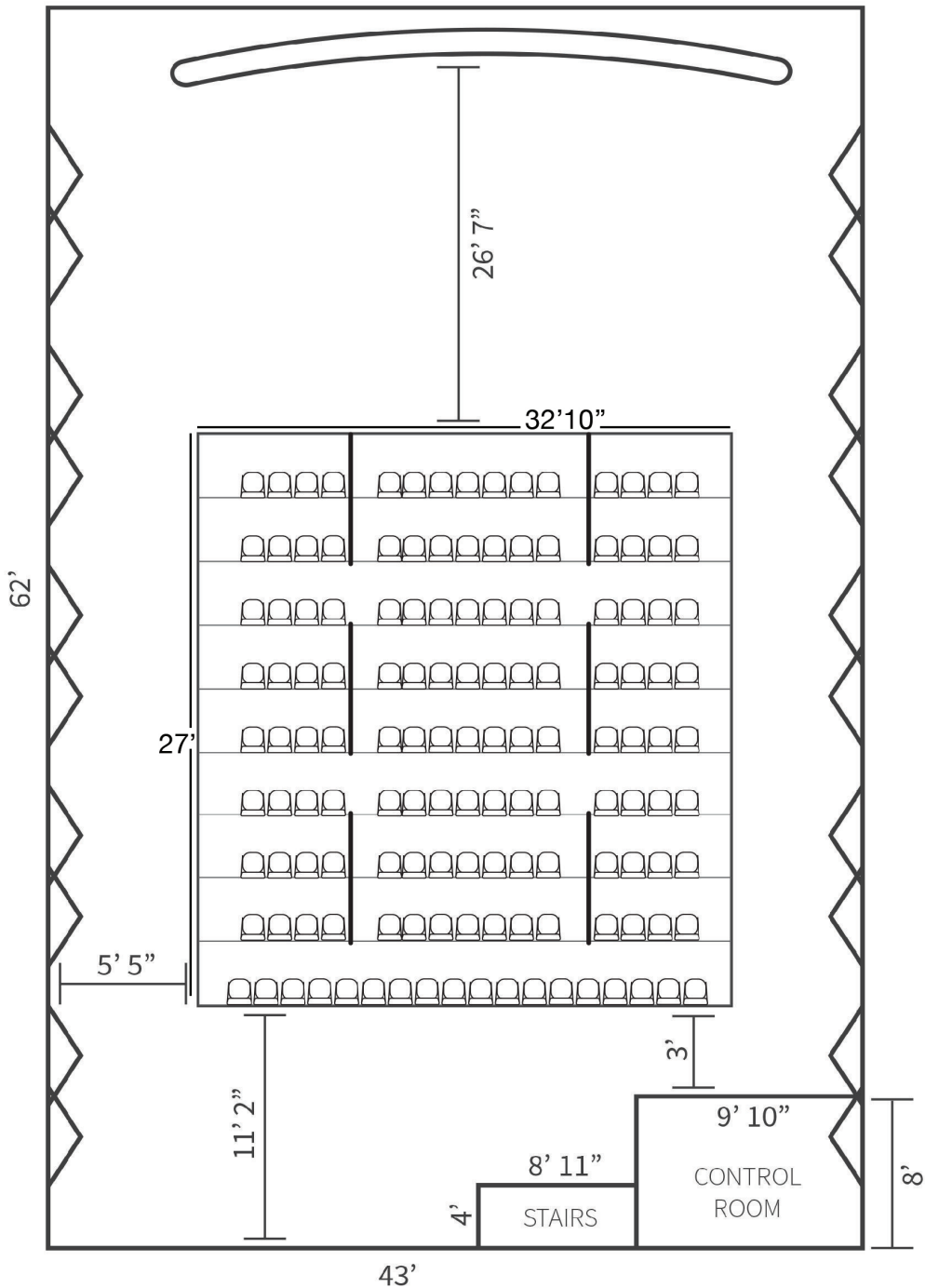

AUDITORIUM

ESB-MACC Auditorium | 2,666 sq. ft. | Occupancy: 175





BLACK BOX THEATRE

Black Box Theatre | Riser sits 70: 50 Chairs/32 Chairs with tables

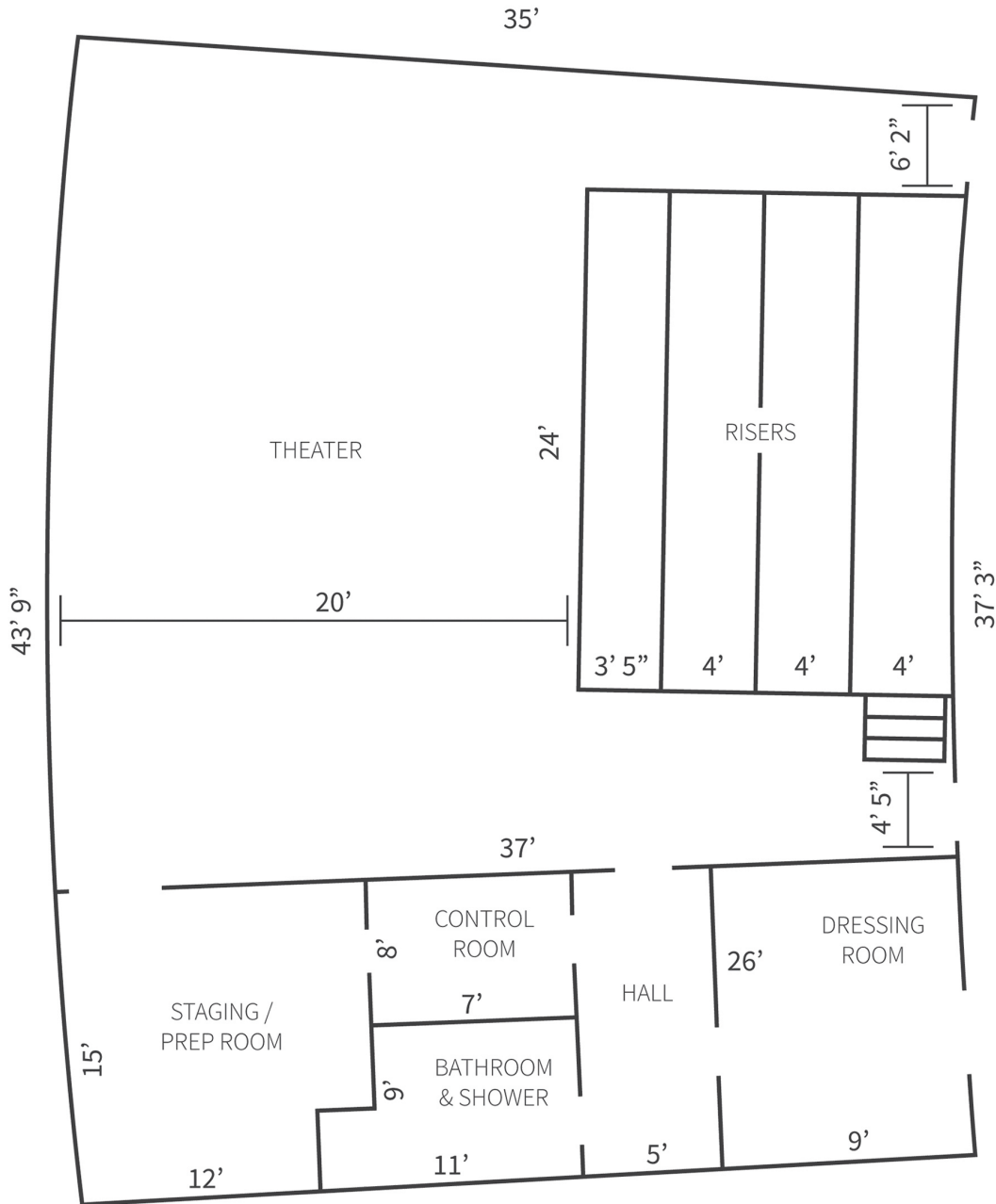



COMMUNITY GALLERY

Note: Each glass partition is 1'10" wide, and spaced 4'11" apart

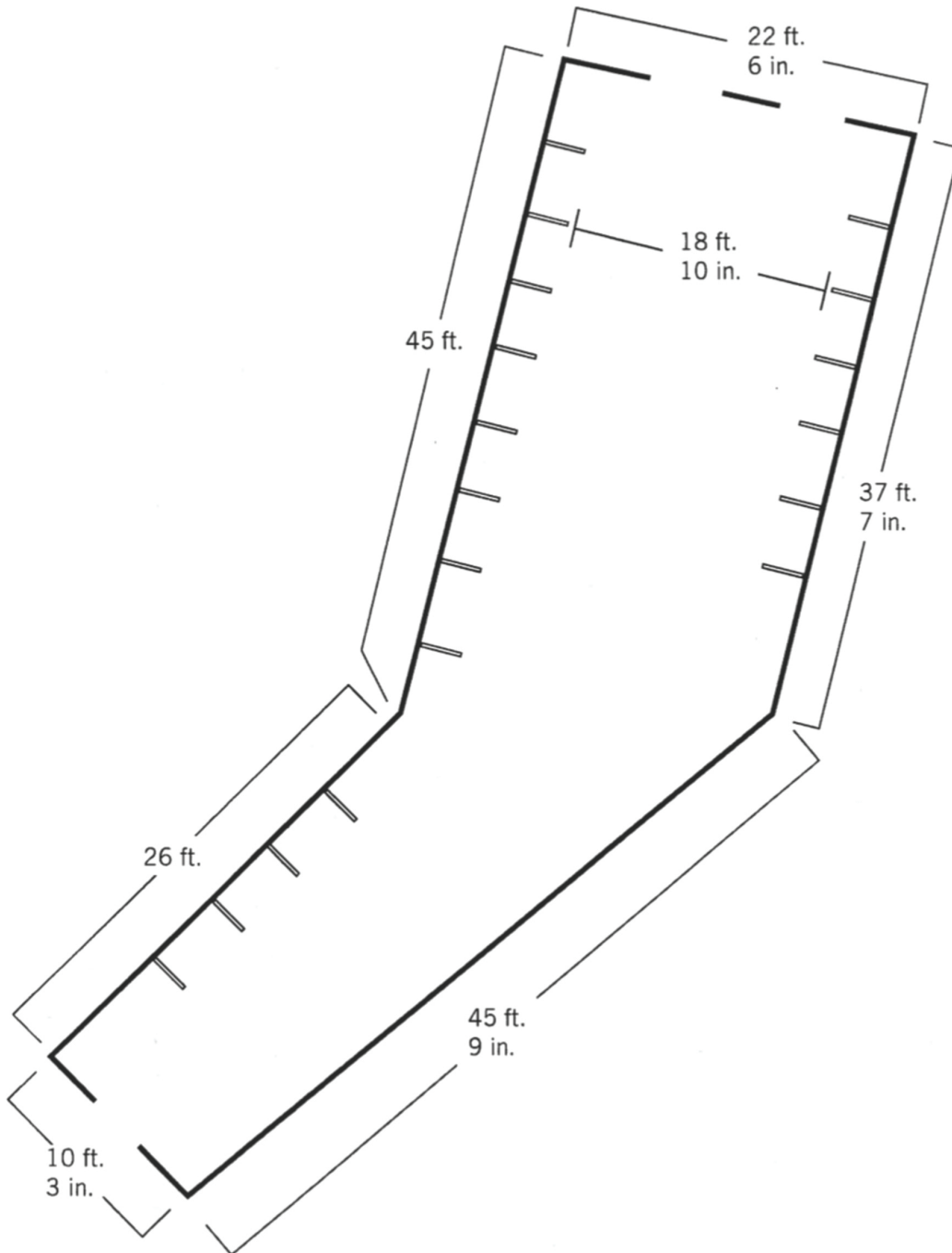



DANCE STUDIO

ESB-MACC Dance Studio | 50 Chairs/30 Chairs with tables

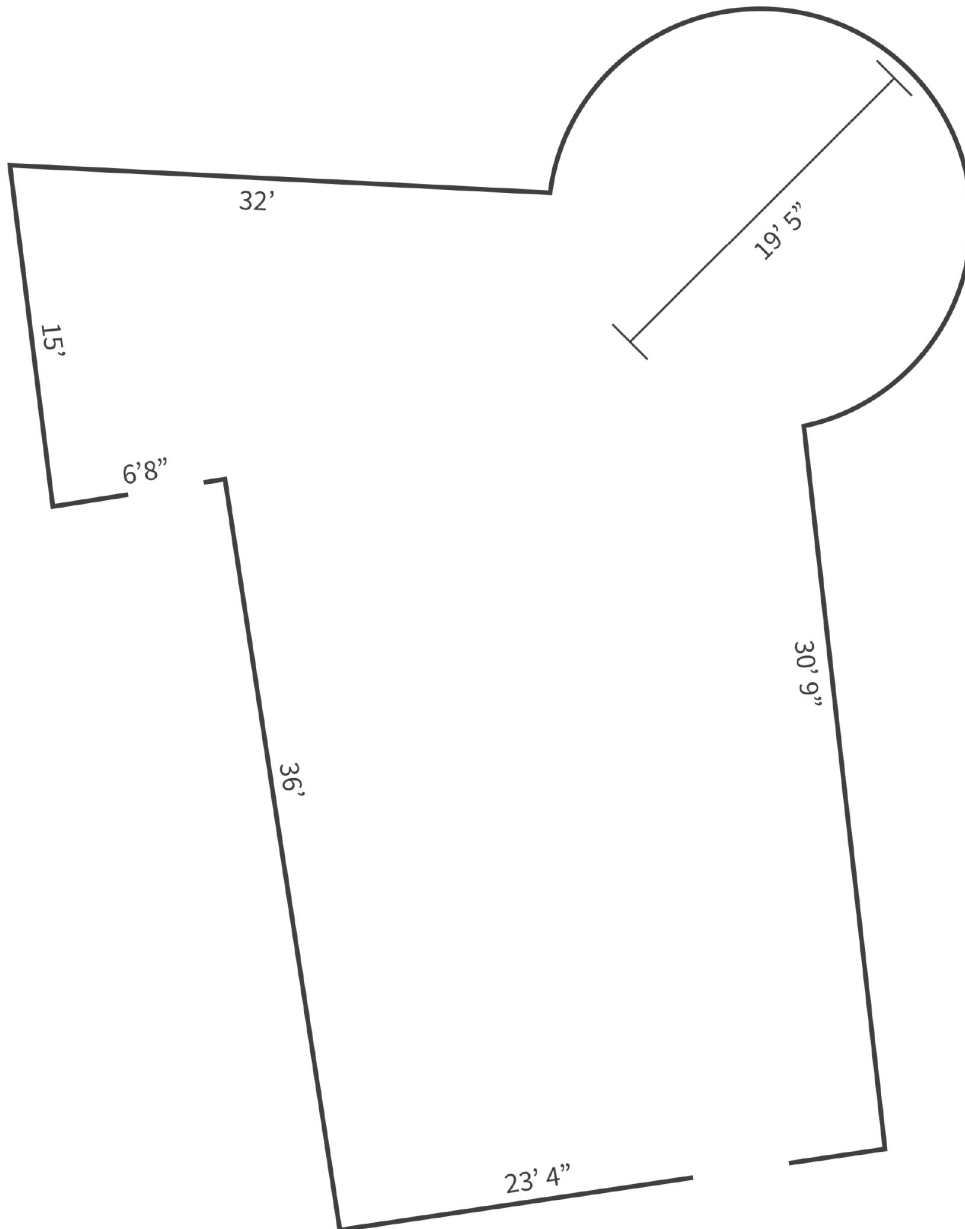



PARKING LOT

Handicap: 6 ■ | Visitor: 5 ■ | Electric Vehicle: 2 ■ | Standard: 115 ■

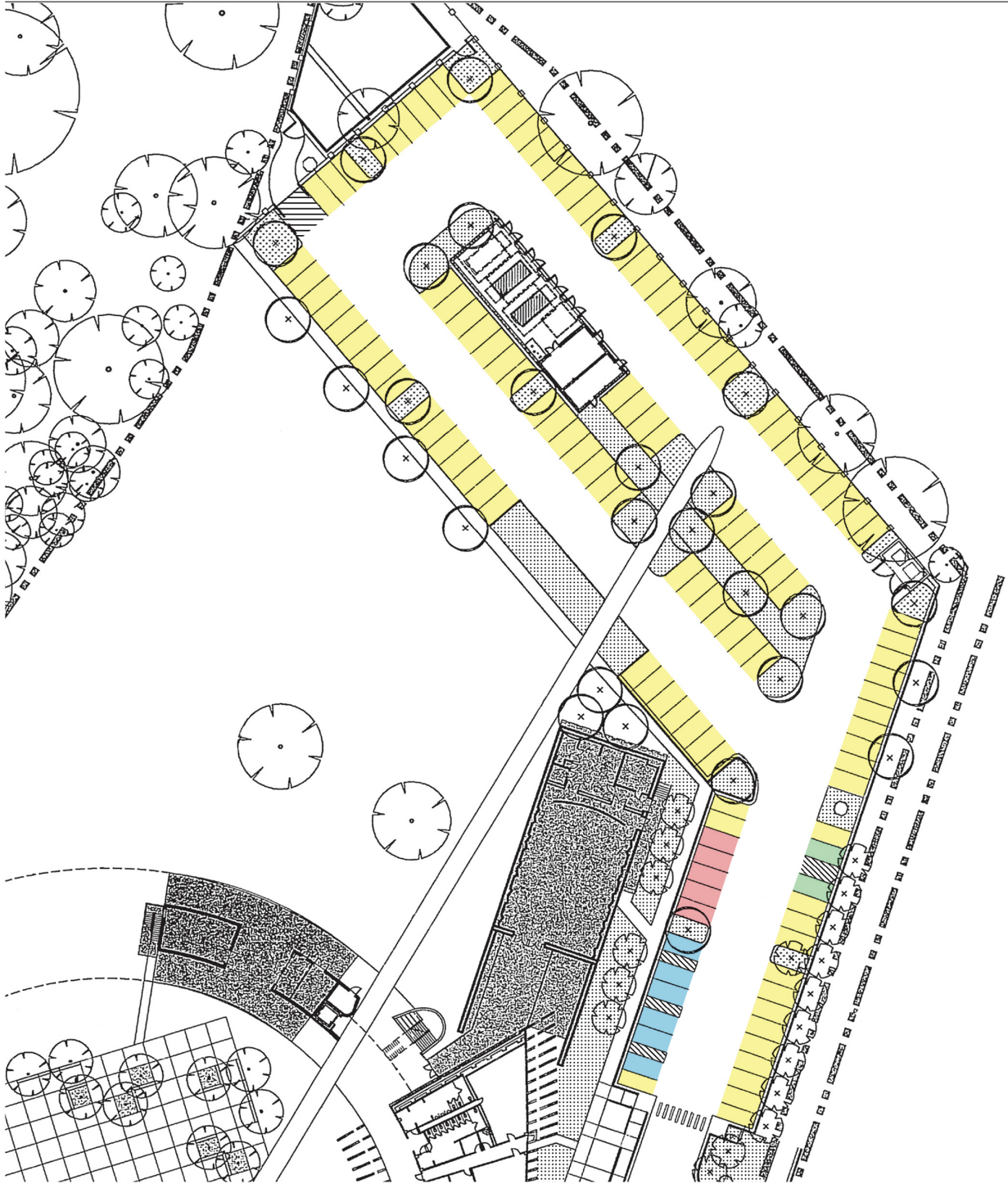



RAUL SALINAS

ESB-MACC Raul Salinas | 35 chairs/20 chairs with tables

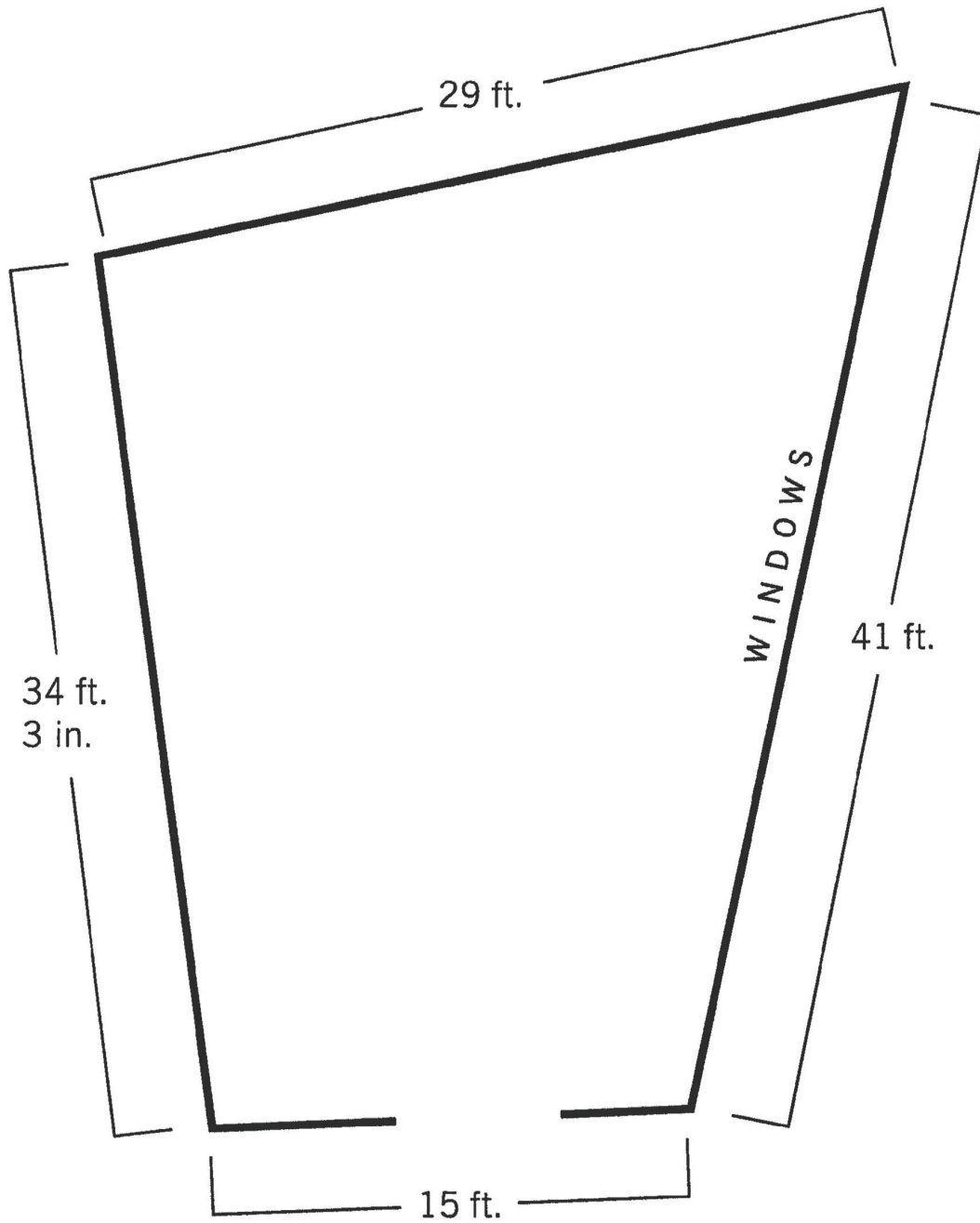



Sam Z. Coronado Gallery

Occupancy: 30

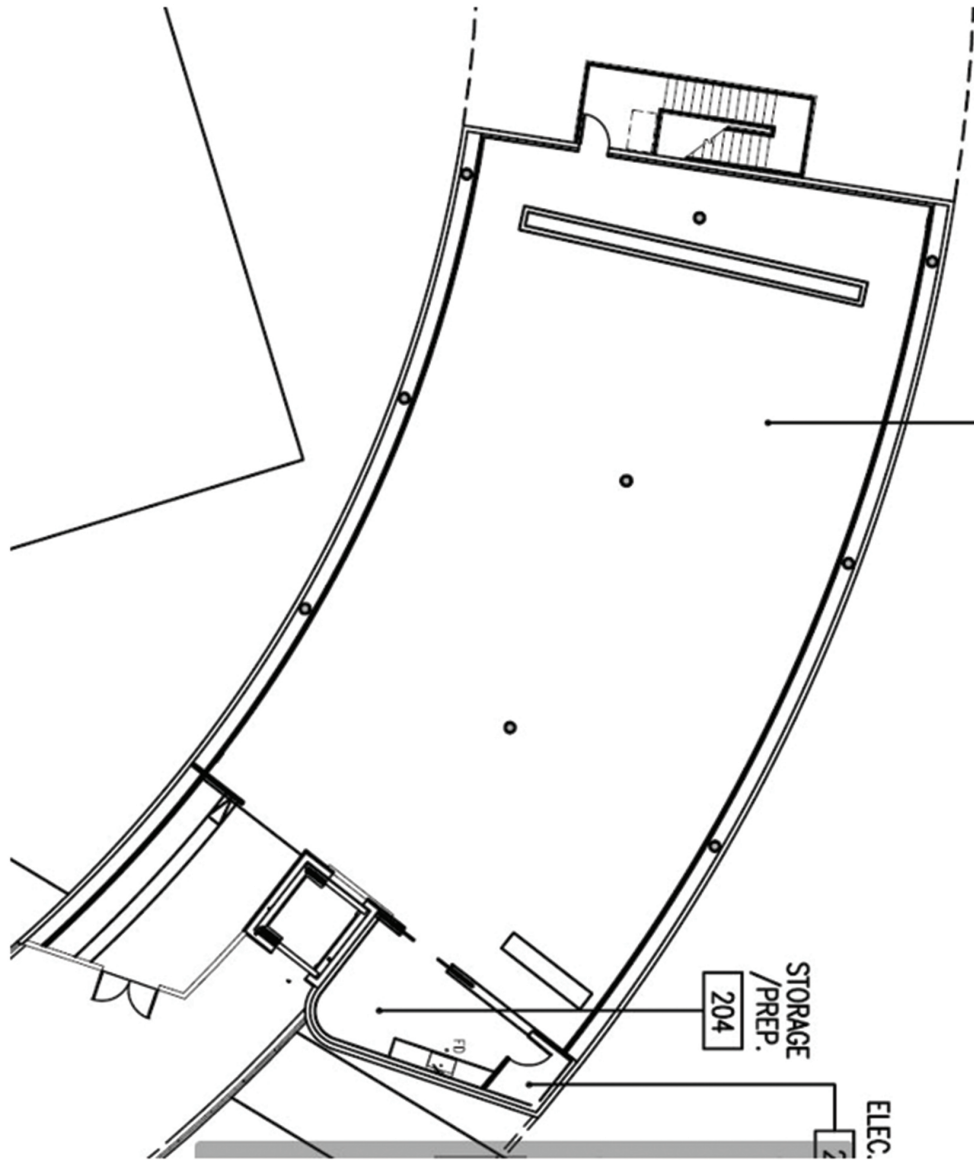



VISUAL ARTS ROOM

Visual Arts Room | Occupancy: 40

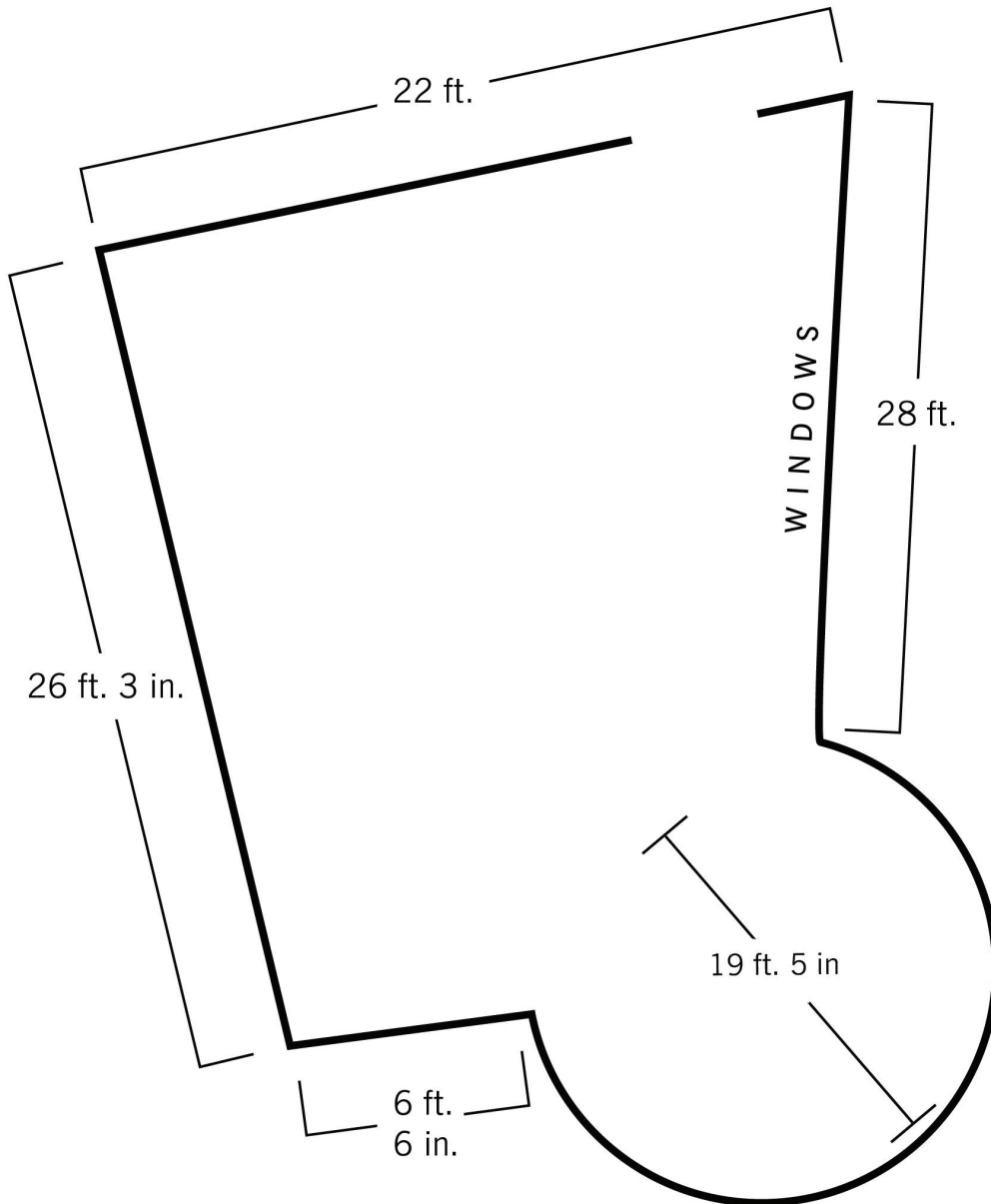



21,600 sq. ft. | Occupancy: 3500

